

Model 203-I
213-F











Avyna





Rectangular trampolines

Assembly manual

Model 203-I



Model 203-I 215x155 cm			
	Quantity	Part number	
Jumping mat	1	TEPL-203-222	
Galvanized spring L=175mm, ø3.2mm	44	TEPL-200-211/C	
Safety pad	1	TEPL-203-333-I-green or AVGR-203-333-I-grey of CAM-203-333-I-camouflage	
Fastener for Safety pad	8	TEPL-ELAS-A	
L-tube	2	TEPL-203-I-1131	
L-tube	2	TEPL-203-I-1132	
K-tube	2	TEPL-203-I-1141	
K-tube	2	TEPL-203-I-1142	
H-tube	2	TEPL-203-I-1151	
H-tube	2	TEPL-203-I-1152	

Model 203-I 215x155 cm			
	Quantity	Part number	
Inground pin	8	TEPL-PIN	
Inground pin for safety pad	8	TEPL-SP-PIN	
Tool for spring	1	TOOL-SPRING	
Fastener for Safety pad	16	TEPL-ELAS-B	
Users manual	1	208010101	
Warning Card	1	208040101	
Tie rip for warning card	1	209010102	
Safety manual	1	208010301	

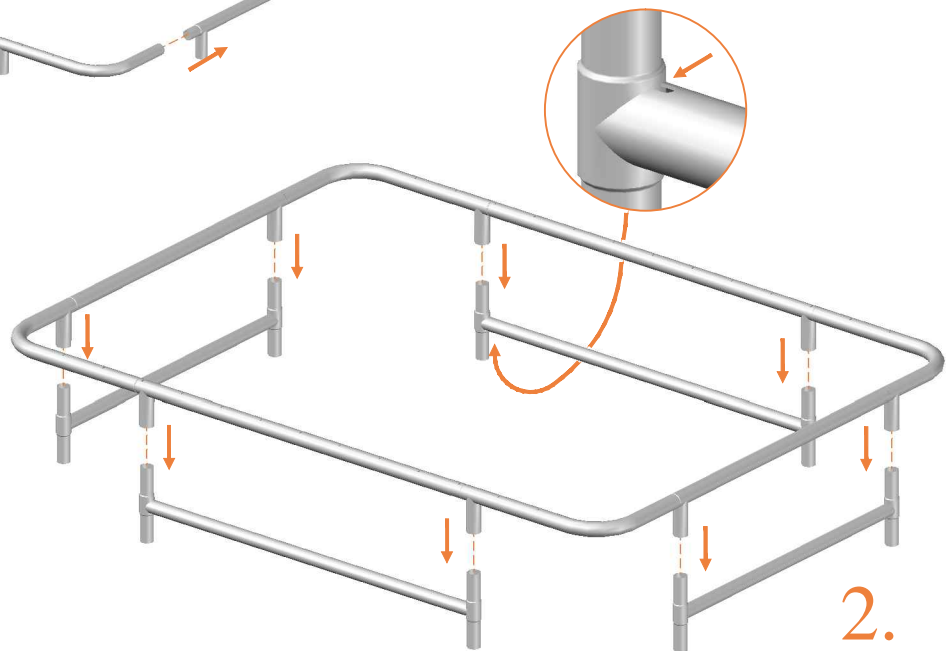
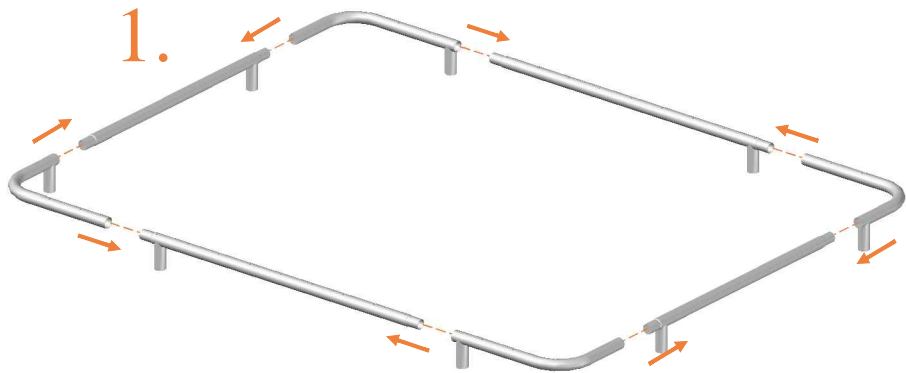

3.

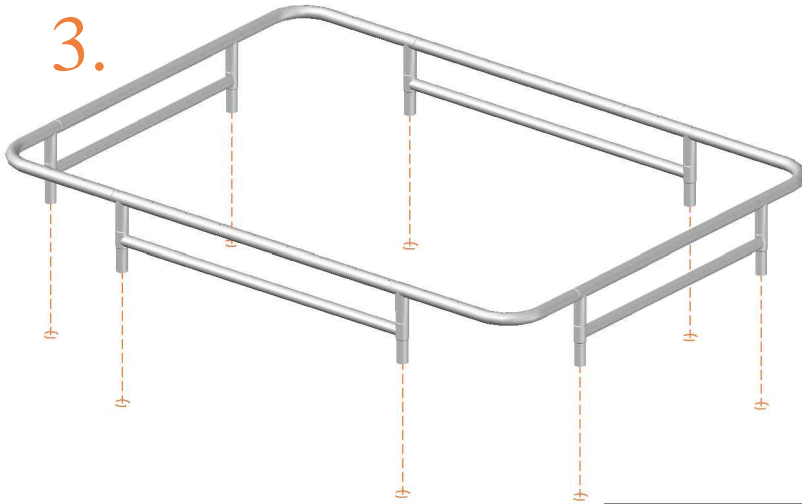

Rubber hammer!

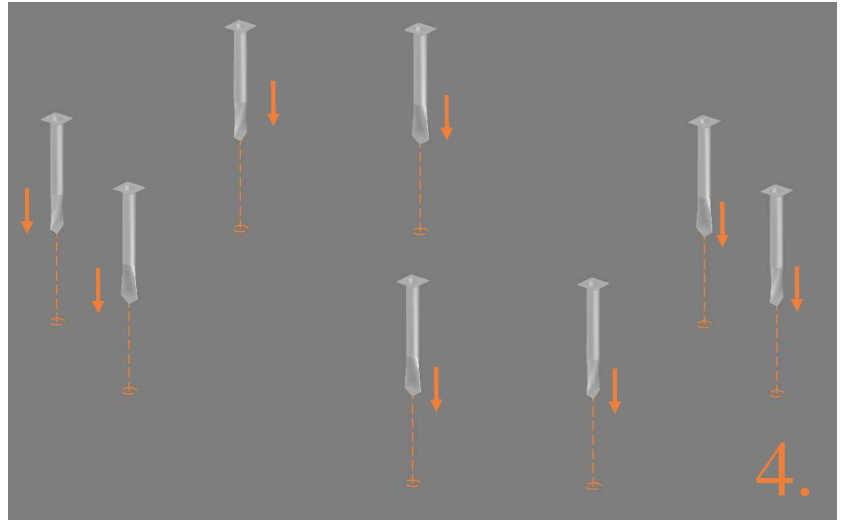

4.

5.

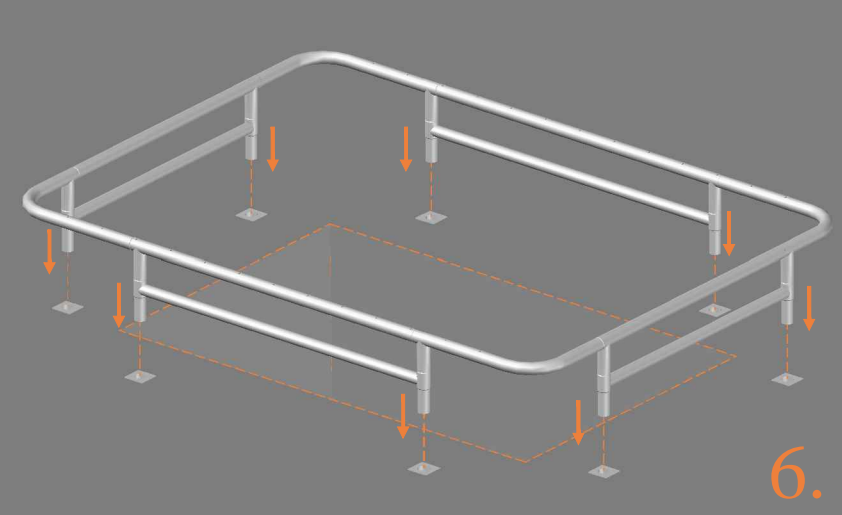
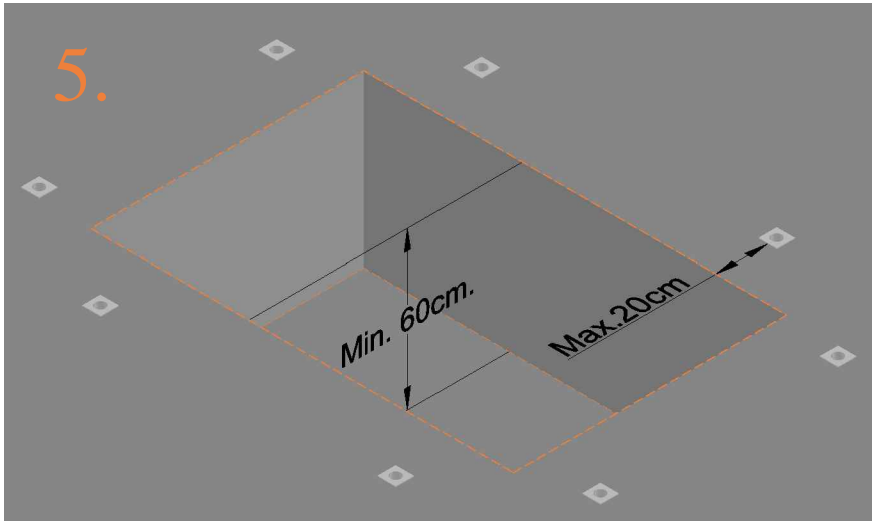

6.

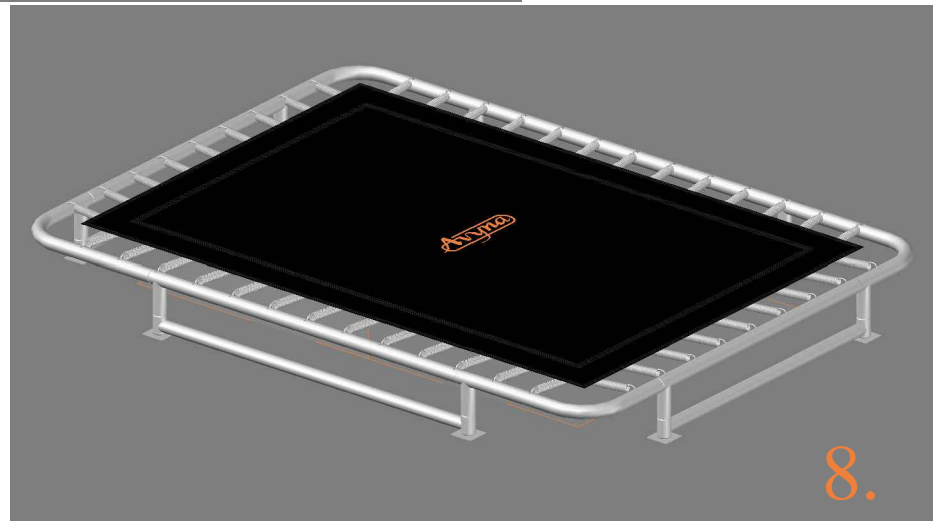
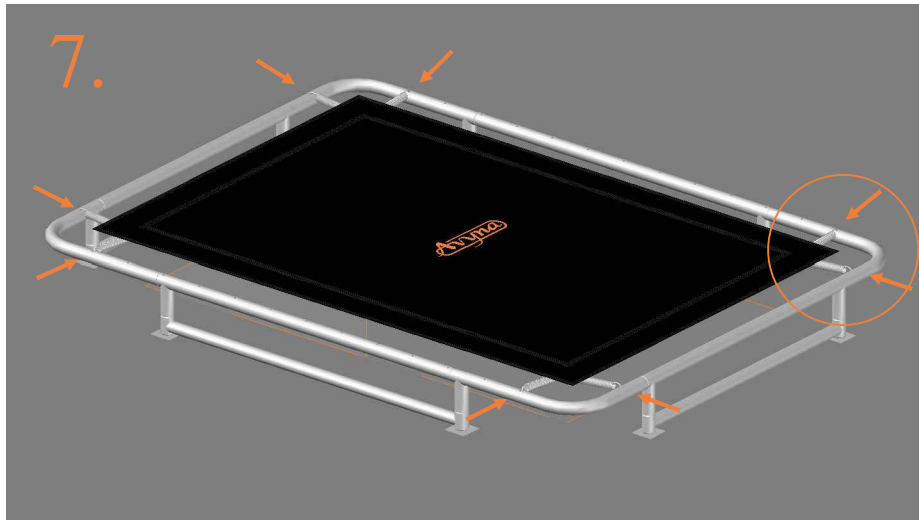

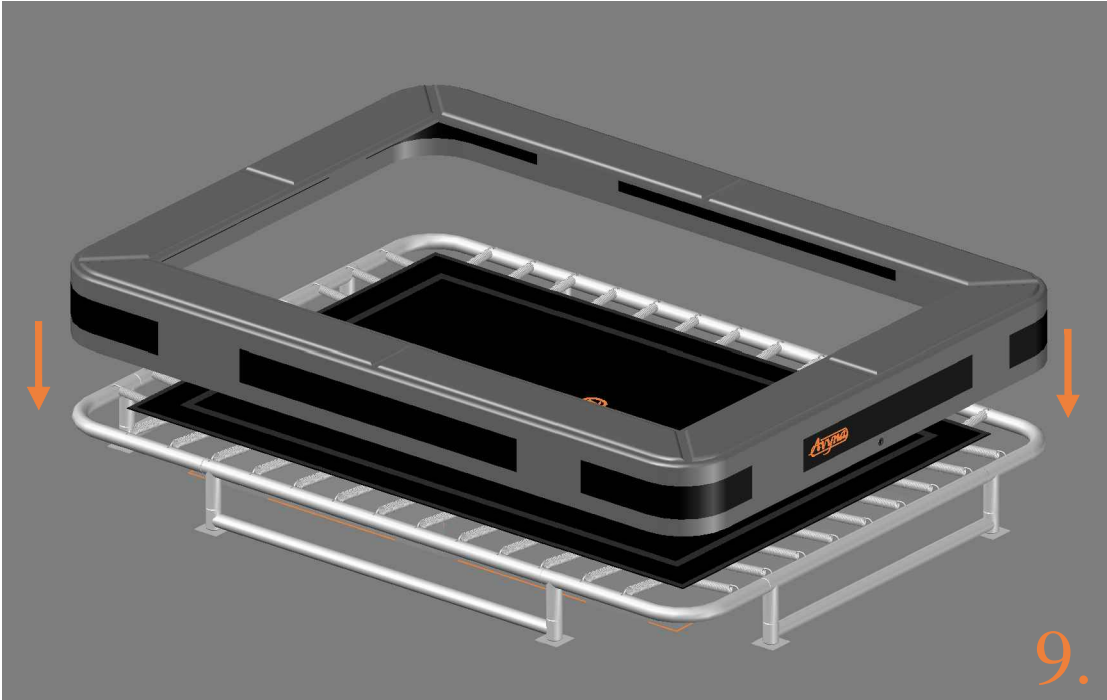

TEPL-ELAS-B

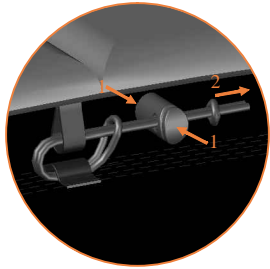
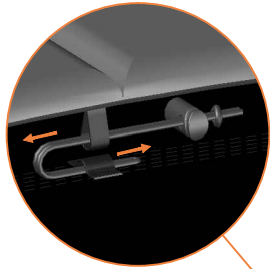

TEPL-ELAS-B

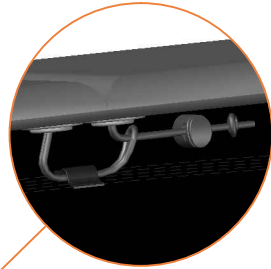

TEPL-ELAS-A

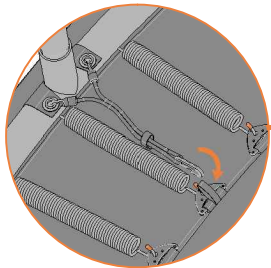



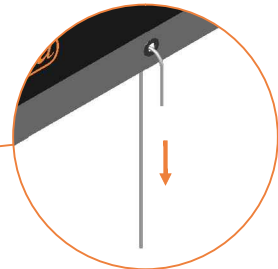
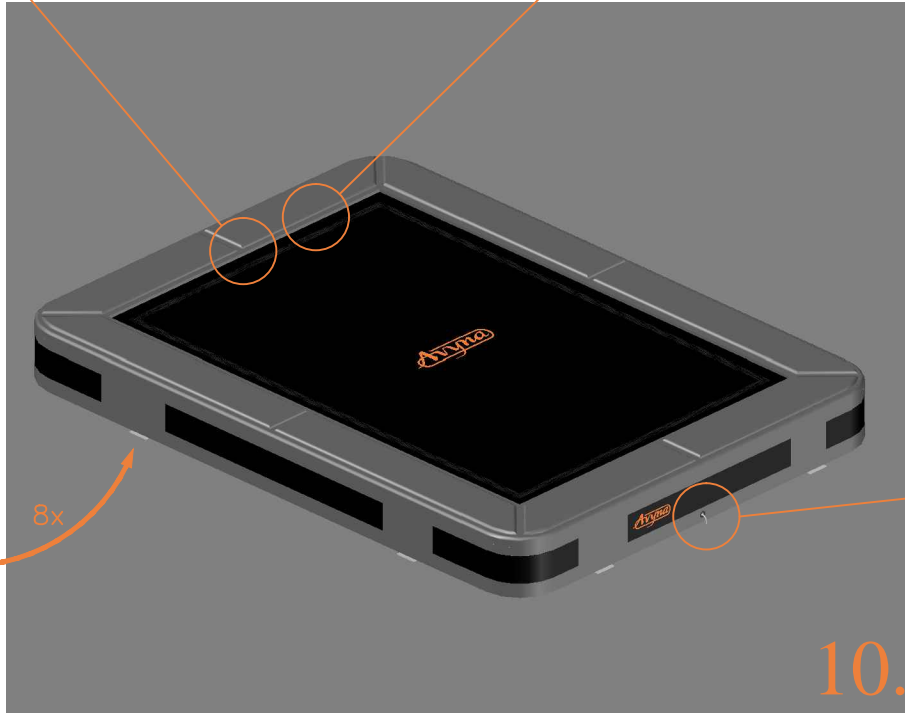





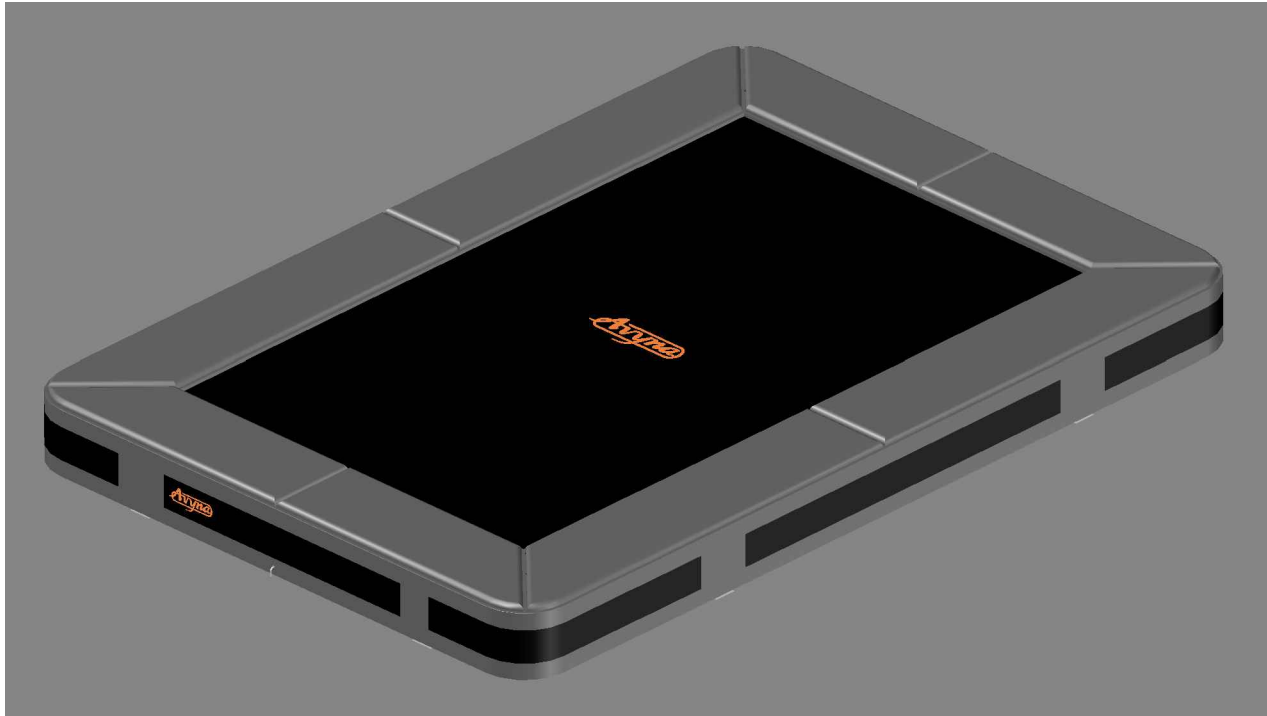



8x











10.

Model 213-I



	Model 213-I 275x190 cm		
	Quantity	Part number	
Jumping mat	1	TEPL-213-222	
Galvanized spring L=175mm, Ø3.2mm	46	TEPL-200-211/C (red cap)	
Galvanized spring L=175mm, Ø3.8mm	10	TEPL-200-211/C (green cap)	
Safety pad	1	TEPL-213-333-I-green or AVGR-213-333-I-grey of CAM-213-333-I-camouflage	
Fastener for safety pad	8	TEPL-ELAS-A	
K-tube	2	TEPL-213-I-1141	
L-tube	2	TEPL-213-I-1142	
Allen key	2	ALLEN KEY	
Screw M6	4	090-M6-45	
Screw M8	8	090-M8-60	
Wrench M8	2	WRENCH M8	
Fastener for safety pad	20	TEPL-ELAS-B	

	Model 213-I 275 x 190 cm		
	Quantity	Part number	
H-tube	2	TEPL-213-I-1151	
H-tube	2	TEPL-213-I-1152	
Inground pin	8	TEPL-PIN	
Inground pin for safety pad	8	TEPL-SP-PIN	
Tool for spring	1	TOOL-SPRING	
I-tube	1	TEPL-213-I-1161	
I-tube	1	TEPL-213-I-1162-A	
I-tube	1	TEPL-213-I-1162-B	
T-tube	2	TEPL-213-I-1171	
Safety Manual	1	208010301	
Users Manual	1	208010101	
Warning Card	1	208040101	
Tie rip for warning card	1	209010102	

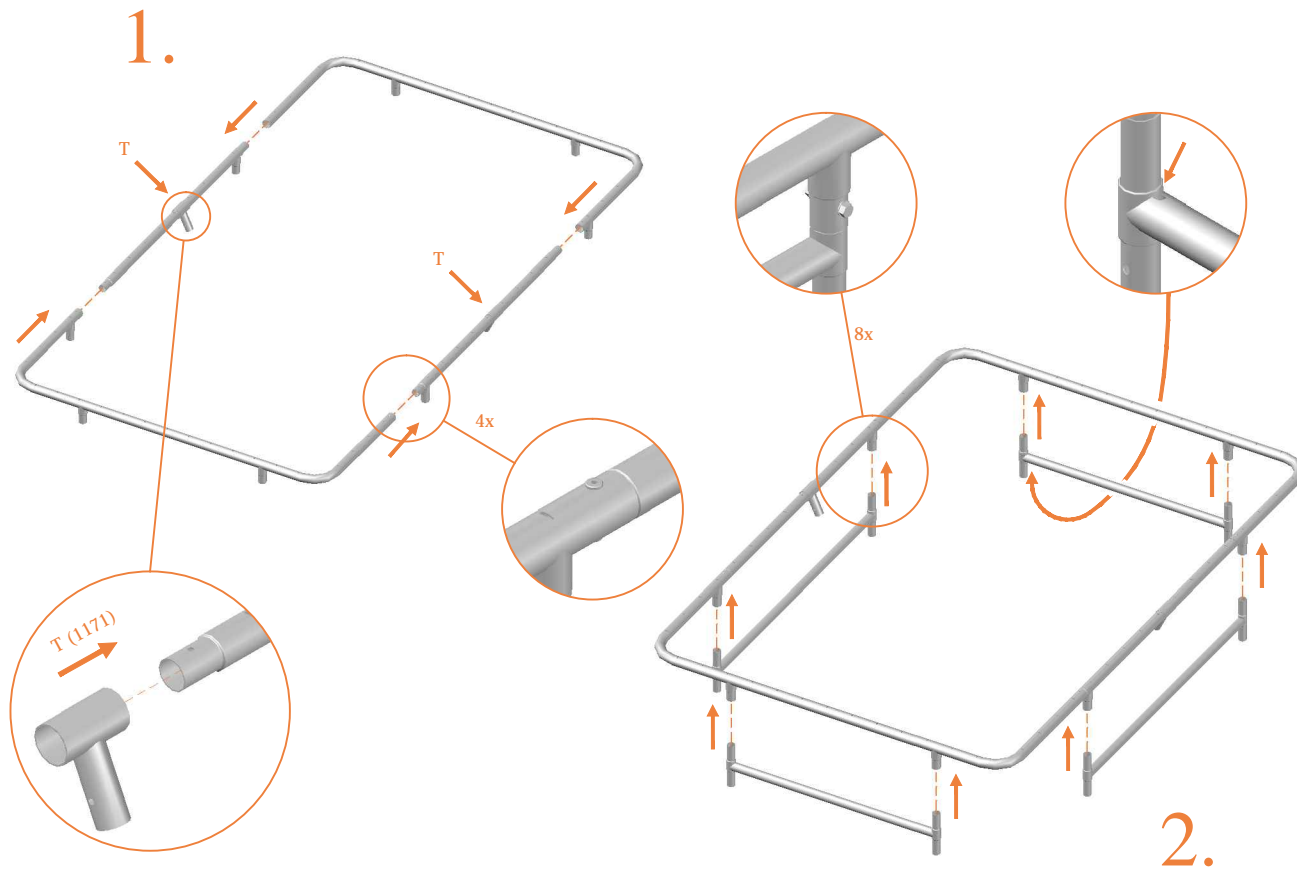

3.

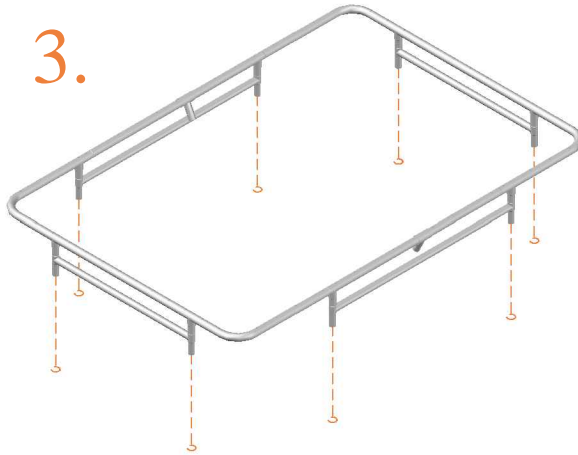

Trampoline	Depth
Model 213-i	60cm

Rubber hammer!



4.

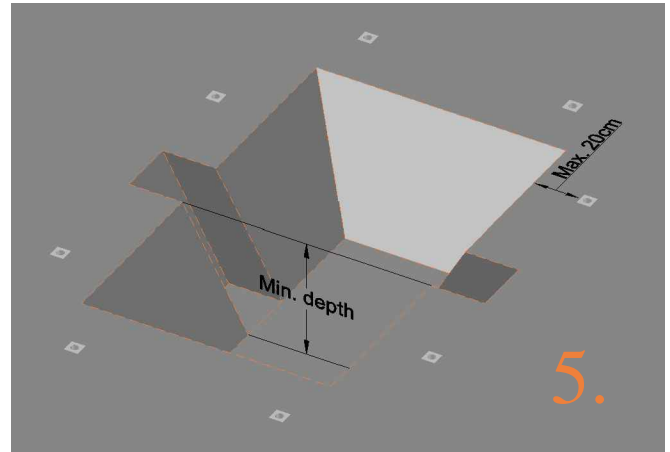
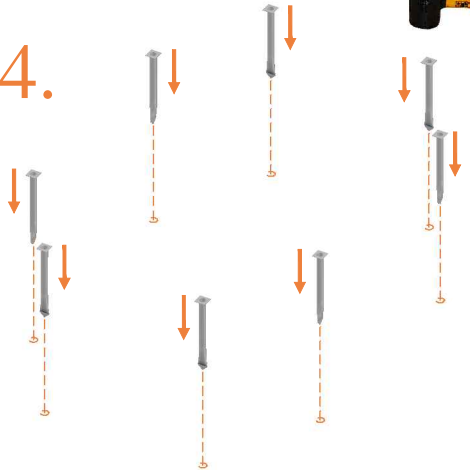

6.

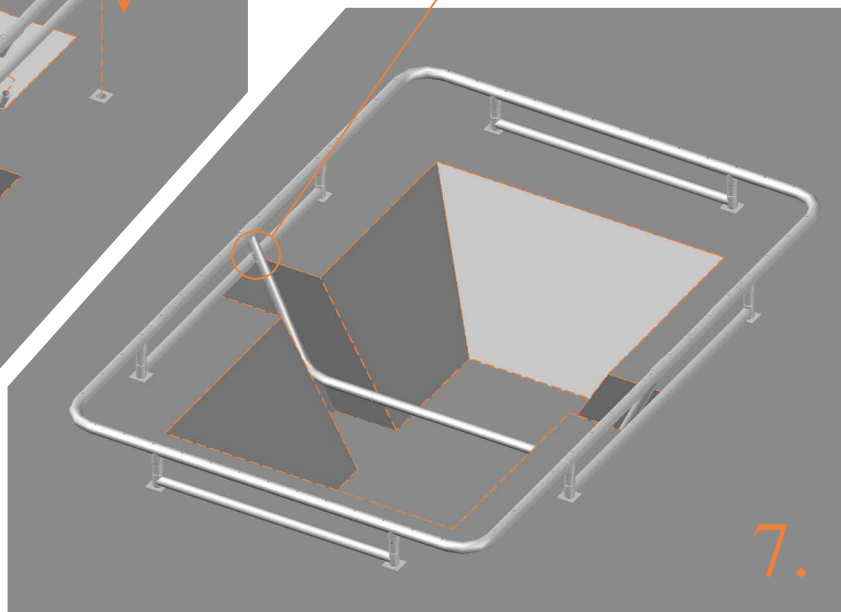
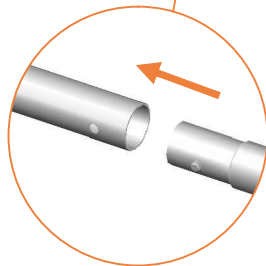
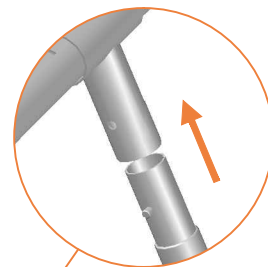
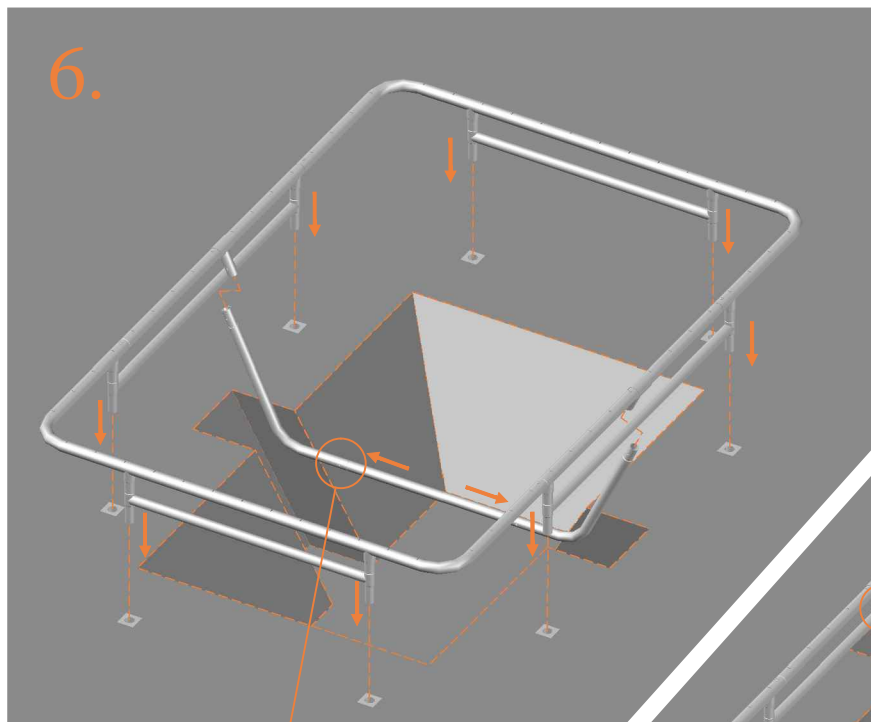

7.

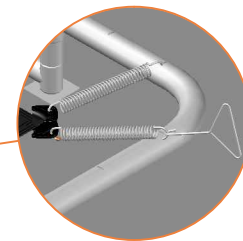

8x 175mm, \varnothing 3.2
(red cap)

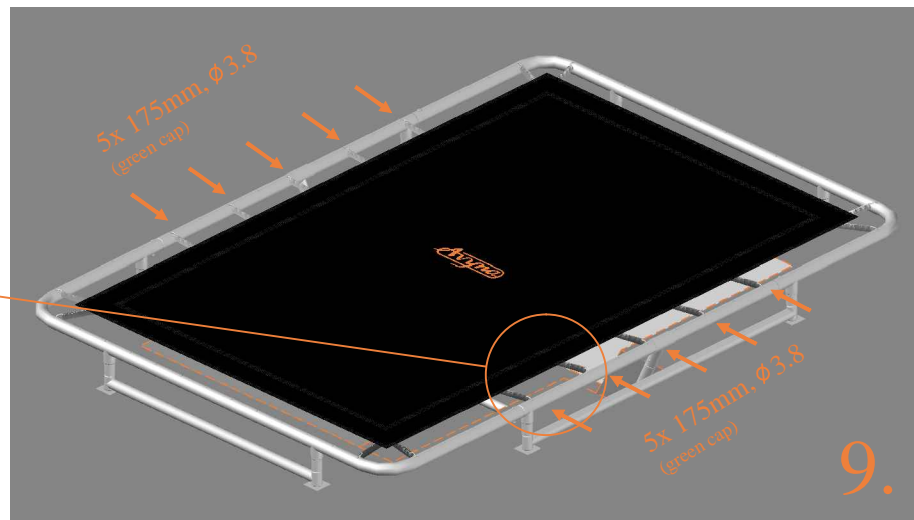
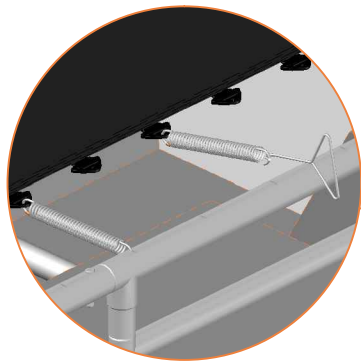

10.

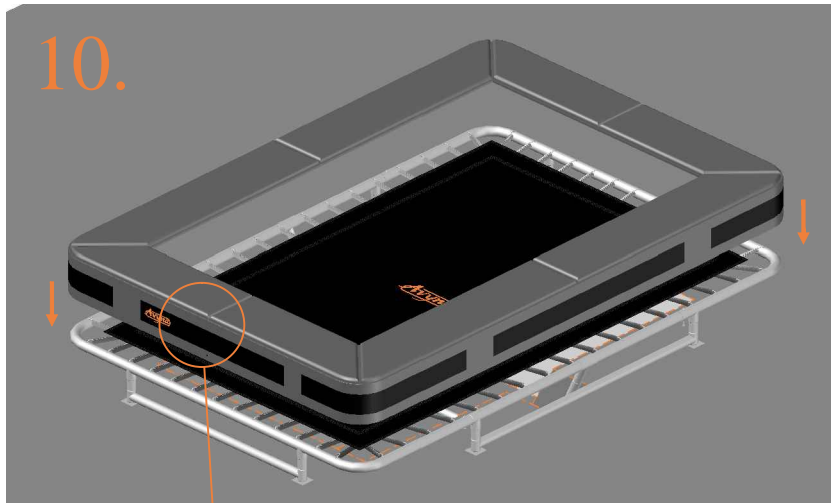

TEPL-ELAS-A

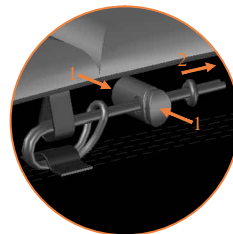
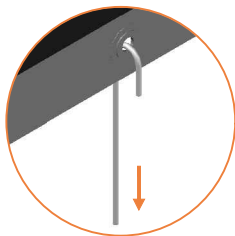
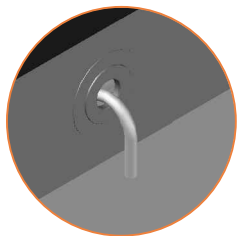
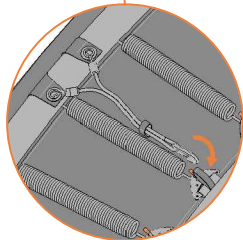

TEPL-ELAS-B

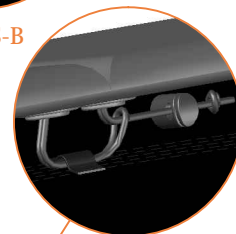

TEPL-ELAS-B

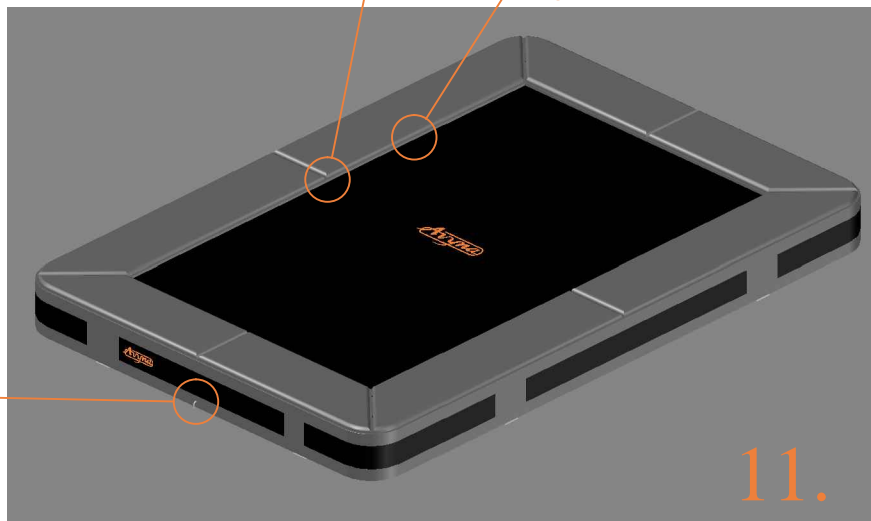



11.











Model 203-I



Model 213-I



Model 203-I 215x155 cm			
Quantity	Part number		
Pole with sleeve for safety net	4	AVBL-203-I-802 A	
Pole for safety net	4	AVBL-203-I-802 B	
Inground anker for pole safety net	4	TOOL-203-SN	
Clamb for pole safety net	8	TEPL-KLEM	
Plastic in between piece pole safety net	4	TEPL-PLASTIC	
Safety-net	1	ANBL-203-I	
Straps for safety net	8	TEPL-BAND 4x long: 1,5m(below) 4x short: 1,0m (above)	
Fastening for safety net	5	TEPL-ELASTIC	
Closure for safety net	2	TEPL-KNOOP	

Model 213-I 275x190			
Quantity	Part number		
Pole with sleeve for safety net	8	AVBL-213-I-802 A	
Pole for safety net	8	AVBL-213-I-802 B	
Clamp	8	CLAMP-TOOL-SN-213-I	
Straps for safety net	16	TEPL-BAND	
Closure for safety net	2	TEPL-KNOOP	
Safety net	1	ANBL-213-I	
Screw M6	8	M6-30	
Screw M8	32	M8-20	
Allen key	2	ALLEN-KEY	
Wrench	2	WRENCH	

Model 213-I

1.

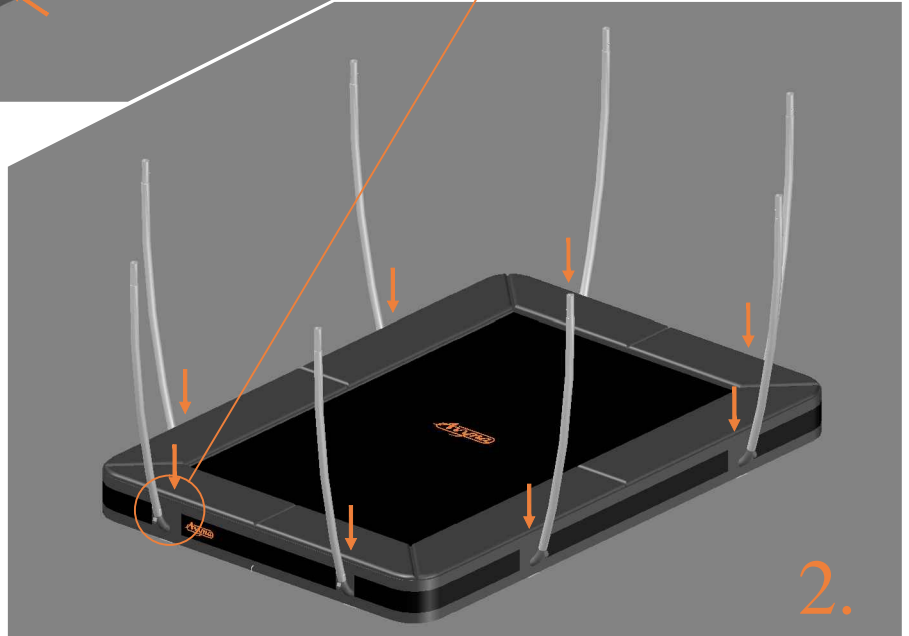
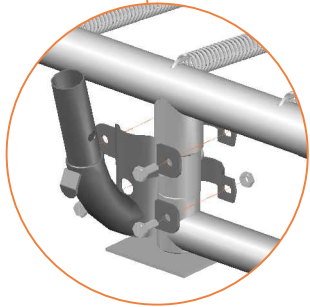
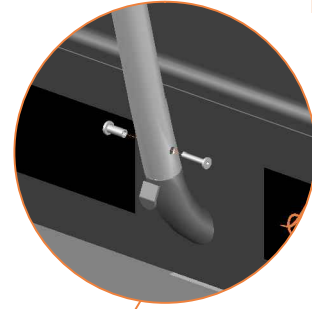

2.

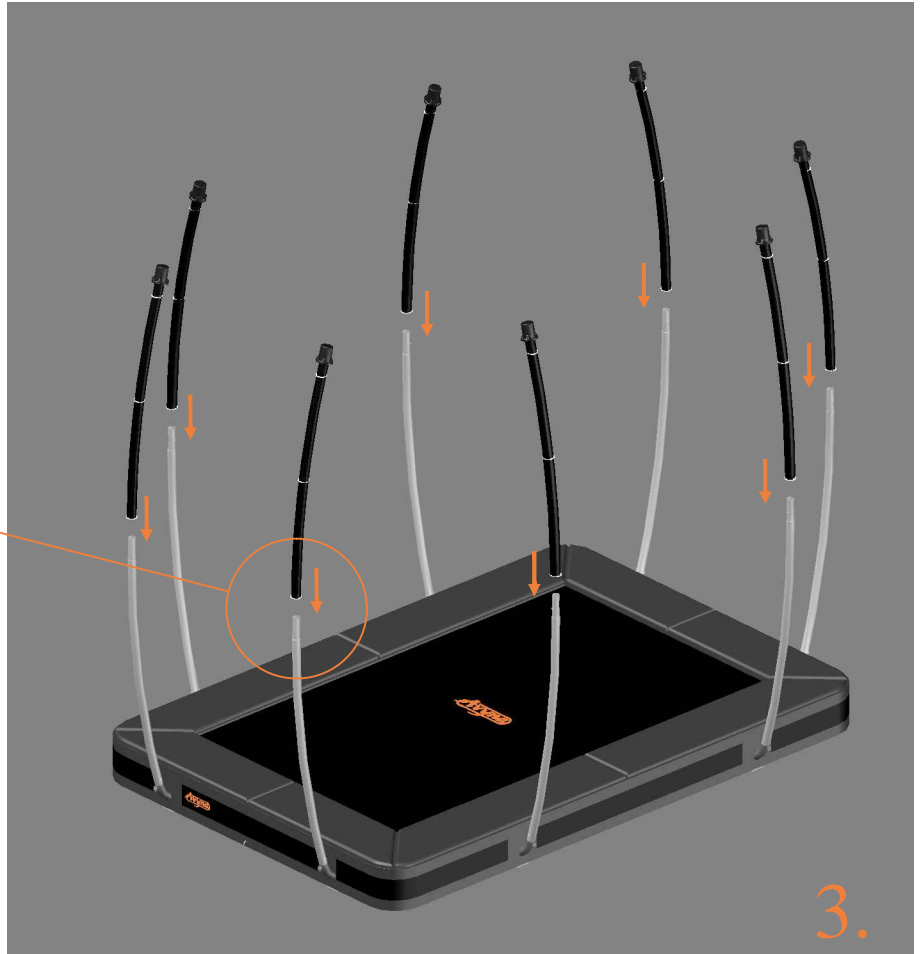
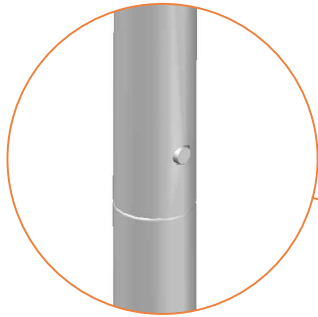

4.



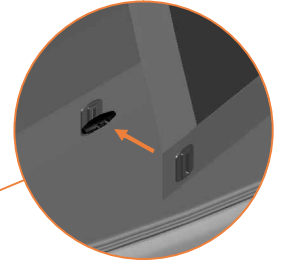
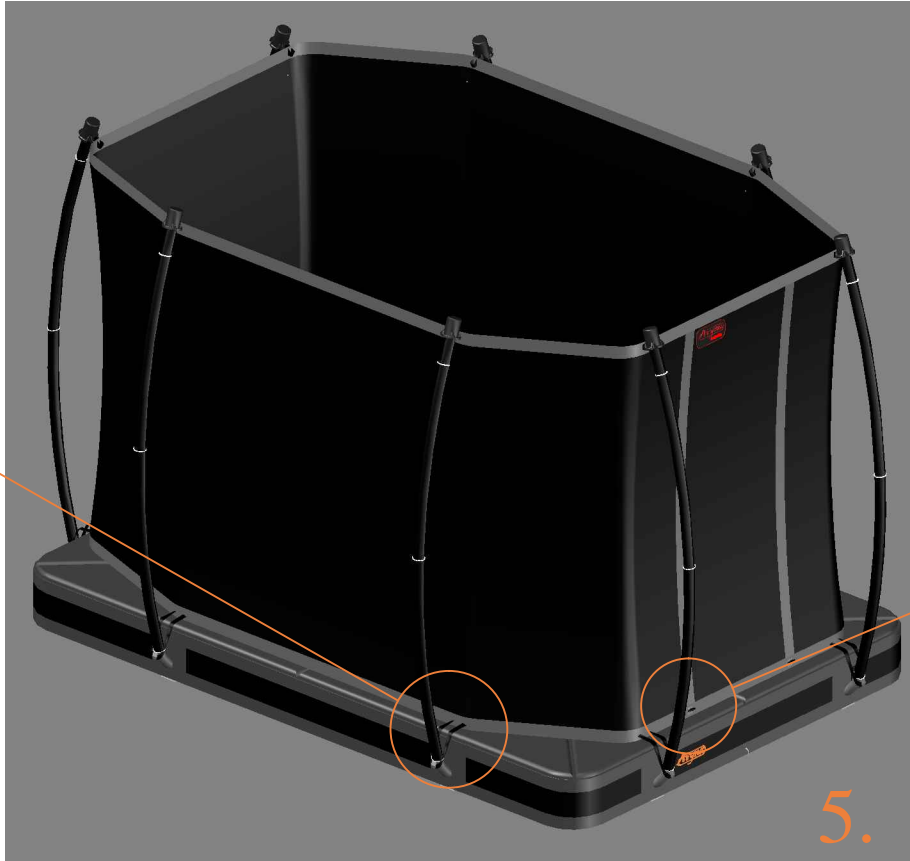
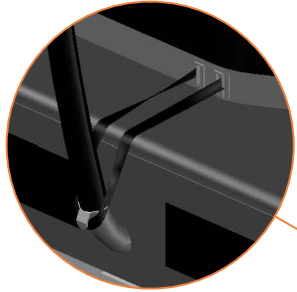



Sales office: Beneluxbaan 7
5121 DC Rijen
The Netherlands
sales@avyna.eu
www.avyna.eu