

Model 223-FL / Model 234-FL
Model 238-FL











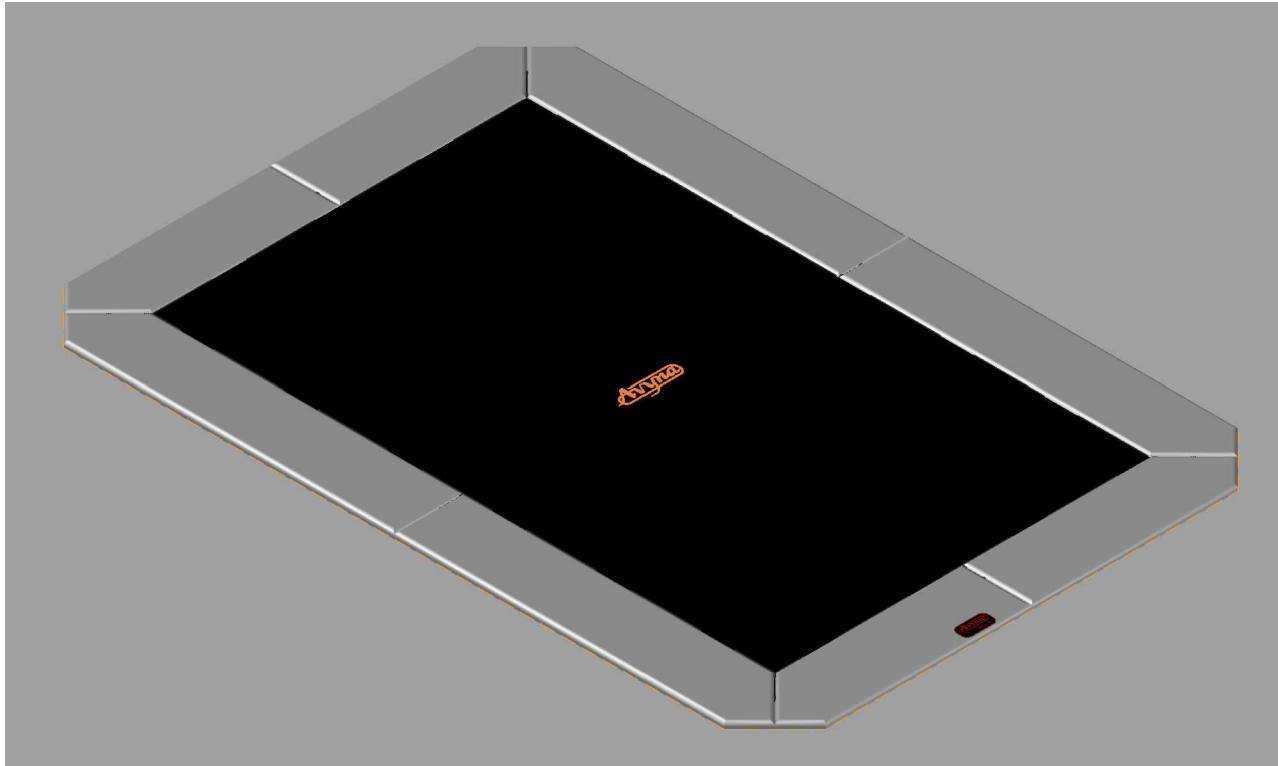



Avyna

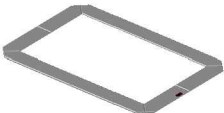





Rectangular Trampolines













Assembly manual







Model 223-FL / Model 234-FL / Model 238-FL













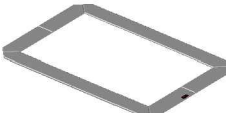





Model-223-FL APPROX 305x225cm			
Quantity	Part number		
Jumping mat	1	TEPL-223-FL-222	
Galvanized spring L=175mm Ø3.2mm	74	TEPL-200-211/C	
Galvanized spring L=140mm Ø3.2mm	4	TEPL-200-211/E	
Safety pad	1	TEPL-223-FL-333-green or AVGR-223-FL-333-grey or AVBL-223-FL-333-black	
Fastener for safety pad	20	TEPL-ELAS-B	
I-tube	2	TEPL-223-FL-802 / A	
I-tube	2	TEPL-223-FL-802 / B	
C-tube	2	TEPL-223-FL-113	
K-tube	2	TEPL-223-FL-114	
Tool for spring	1	TOOL-SPRING	
Screw M8	16	M8-16	
Plastic plate	4	223-FL-121	

Model-223-FL APPROX 305x225cm			
Quantity	Part number		
L-tube	4	TEPL-223-FL-802	
I-tube	8	TEPL-223-FL-115	
Measuring rod L=220mm	1	MEASRING ROD / A	
Measuring rod L=600mm	1	MEASRING ROD / B	
Parker screw	36	M4x16	
Fastener for safety pad	20	TEPL-ELAS-D	
Users Manual	1	208010101	
Warning Card	1	208040101	
Tie rip for warning card	1	209010102	
Safety manual	1	208010301	

Model-234-FL APPROX 340x240cm			
Quantity	Part number		
Jumping mat	1	TEPL-234-FL-222	
Galvanized spring L=215mm ø3.2mm	78	TEPL-200-211/A	
Galvanized spring L=175mm ø3.2mm	4	TEPL-200-211/C	
Safety pad	1	TEPL-234-FL-333-green or AVGR-234-FL-333-grey or AVBL-234-FL-333-BLACK	
Fastener for safety pad	20	TEPL-ELAS-B	
I-tube	2	TEPL-234-FL-802 / A	
I-tube	2	TEPL-234-FL-802 / B	
C-tube	2	TEPL-234-FL-113	
K-tube	2	TEPL-234-FL-114	
Tool for spring	1	TOOL-SPRING	
Screw	16	M8-16	
Plastic plate	4	234-FL-121	

Model-234-FL APPROX 340x240cm			
Quantity	Part number		
L-tube	4	TEPL-234-FL-802	
I-tube	8	TEPL-234-FL-115	
Measuring rod L=220mm	1	MEASRING ROD / A	
Measuring rod l=800mm	1	MEASRING ROD / B	
Parker screw M4	36	M4x16	
Fastener for safety pad	20	TEPL-ELAS-D	
Users Manual	1	208010101	
Warning Card	1	208040101	
Tie rip for warning card	1	209010102	
Safety manual	1	208010301	

Model-238-FL APPROX 380x255cm			
	Quantity	Part number	
Jumping mat	1	TEPL-238-FL-222	
Galvanized spring L=215mm Ø3.2mm	90	TEPL-200-211/A	
Galvanized spring L=175mm Ø3.2mm	4	TEPL-200-211/C	
Safety pad	1	TEPL-238-FL-333-green or AVGR-238-FL-333-grey or AVBL-238-FL-333-BLACK	
Fastener for safety pad	20	TEPL-ELAS-B	
I-tube	2	TEPL-238-FL-802 / A	
I-tube	2	TEPL-238-FL-802 / B	
C-tube	2	TEPL-238-FL-113	
K-tube	2	TEPL-238-FL-114	
Tool for spring	1	TOOL-SPRING	
Screw	16	M8-16	
Plastic plate	4	238-FL-121	

Model-238-FL APPROX 380x255cm			
	Quantity	Part number	
L-tube	4	TEPL-238-FL-802	
I-tube	8	TEPL-238-FL-115	
Measuring rod L=220mm	1	MEASRING ROD / A	
Measuring rod L=800mm	1	MEASRING ROD / B	
Parker screw	36	M4x16	
Fastener for safety pad	20	TEPL-ELAS-D	
Users Manual	1	208010101	
Warning Card	1	208040101	
Tie rip for warning card	1	209010102	
Safety manual	1	208010301	

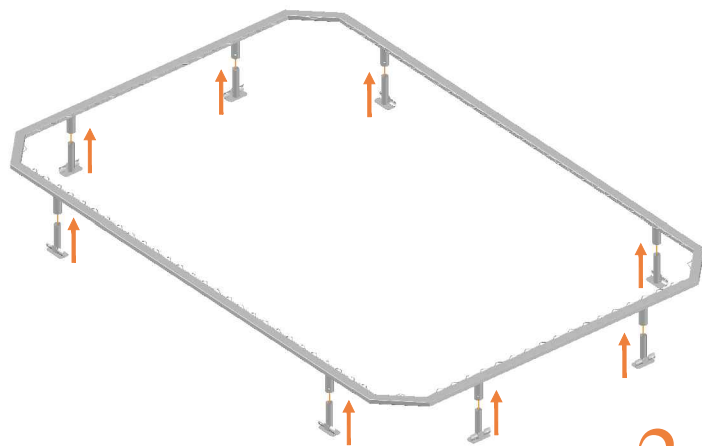
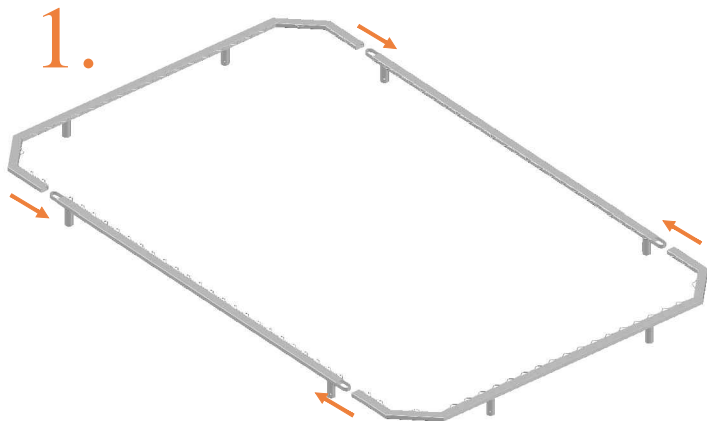

2.

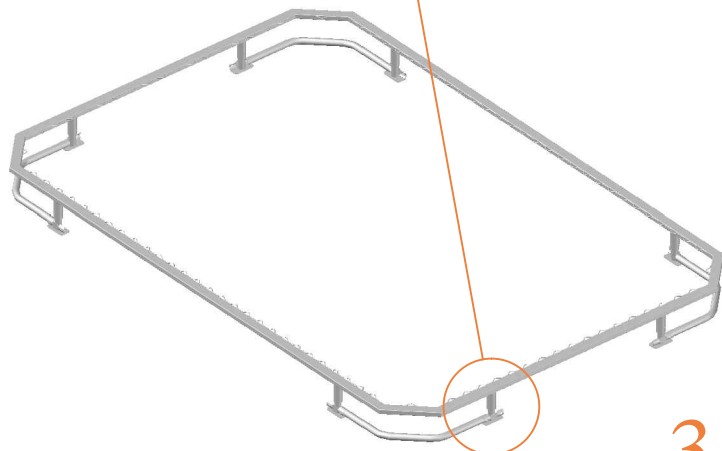
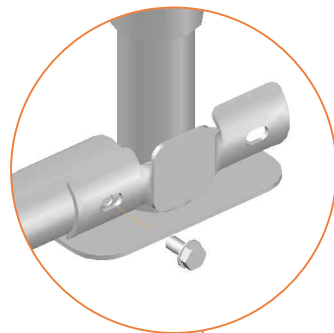

3.

4.

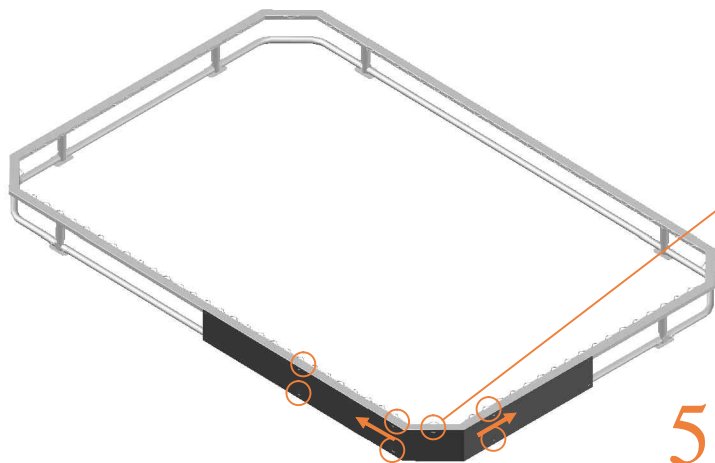
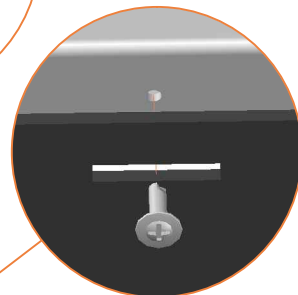
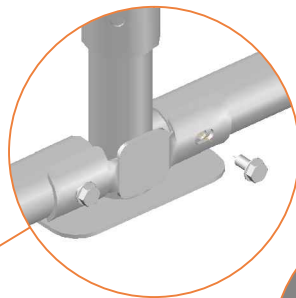
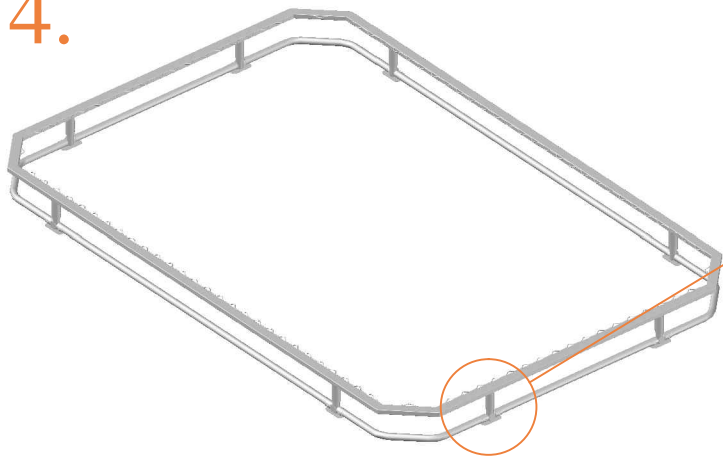

5.

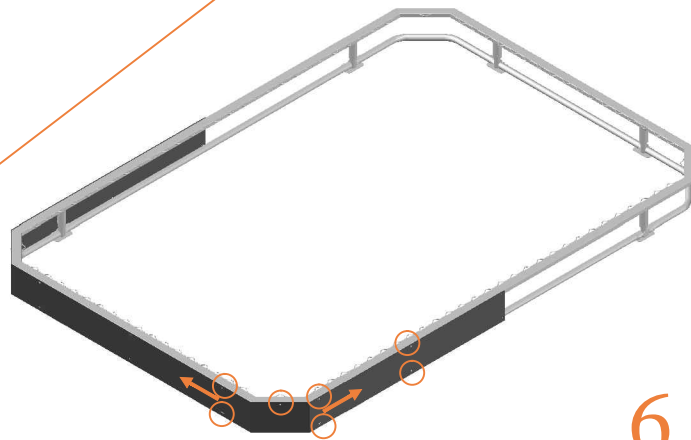

6.

7.

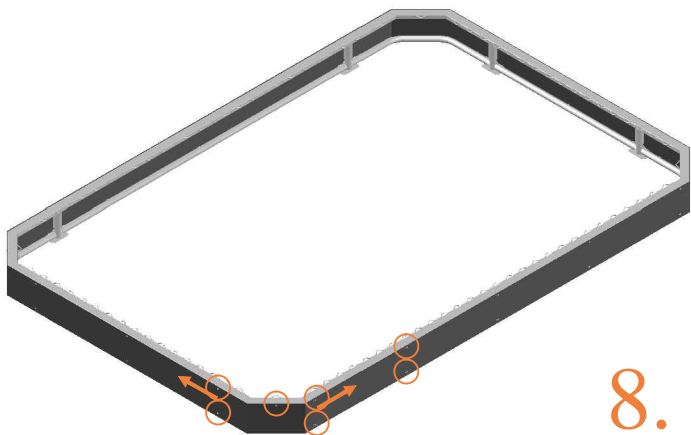
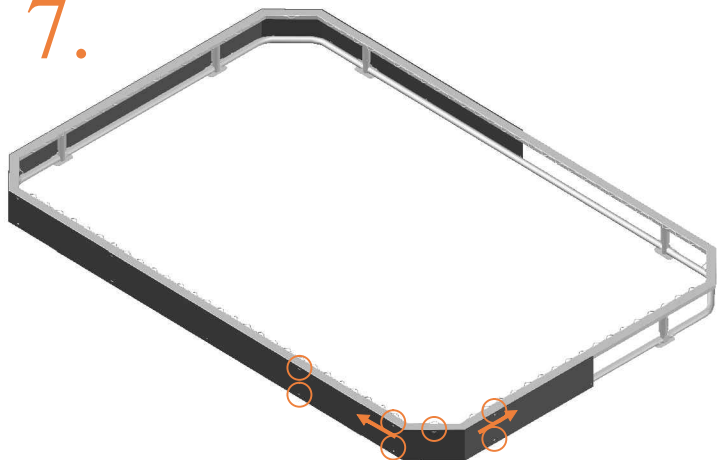

8.

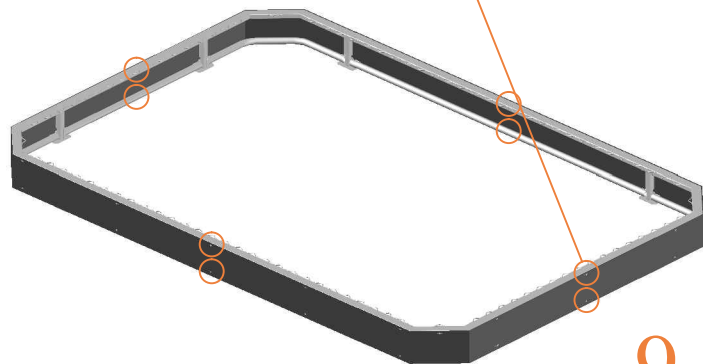
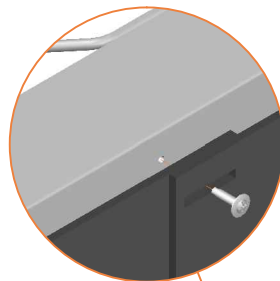

9.

10.

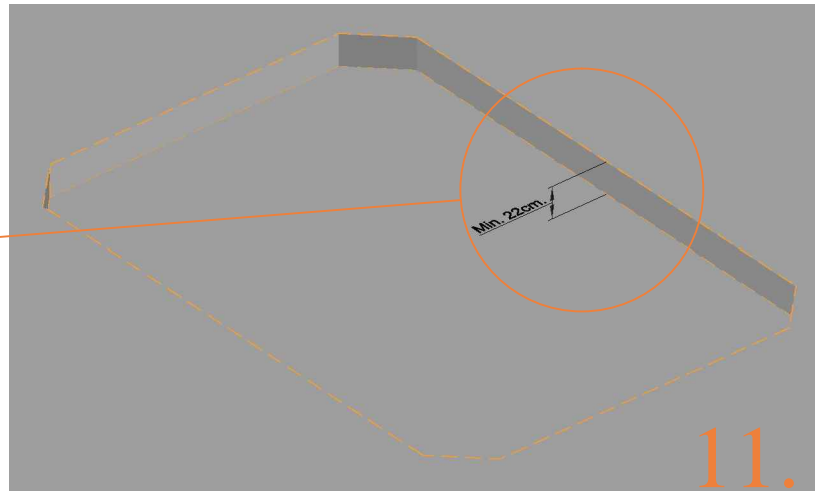
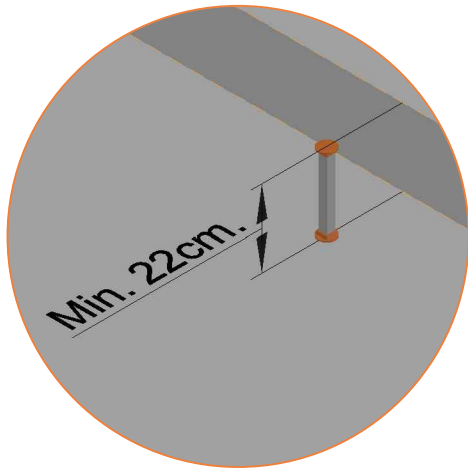
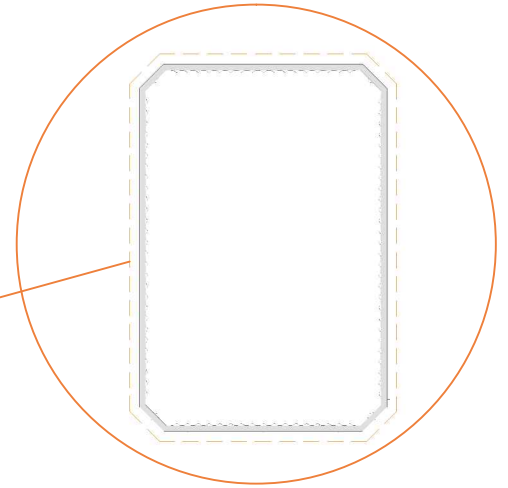
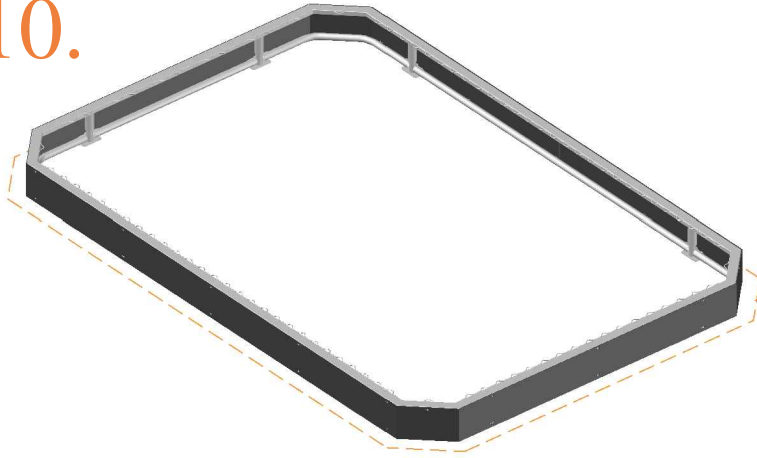

11.

12.

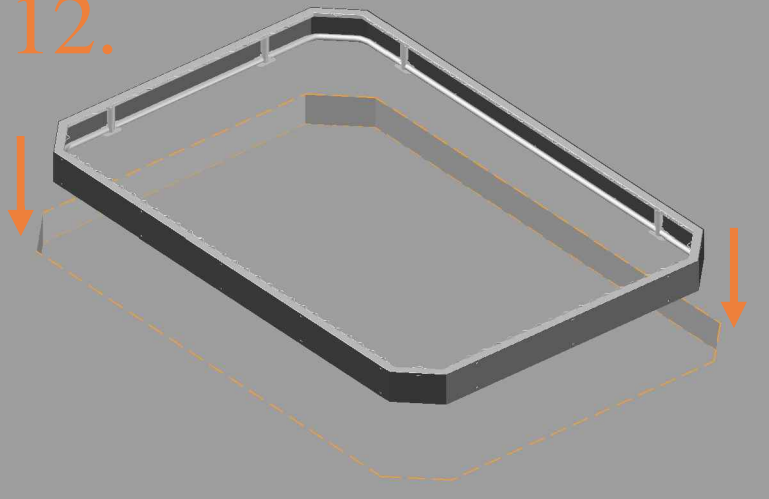

223- FL : Max.20cm
234-FL / 238-FL: Max.25cm

223- FL : Min.60cm
234-FL / 238-FL: Min.80cm

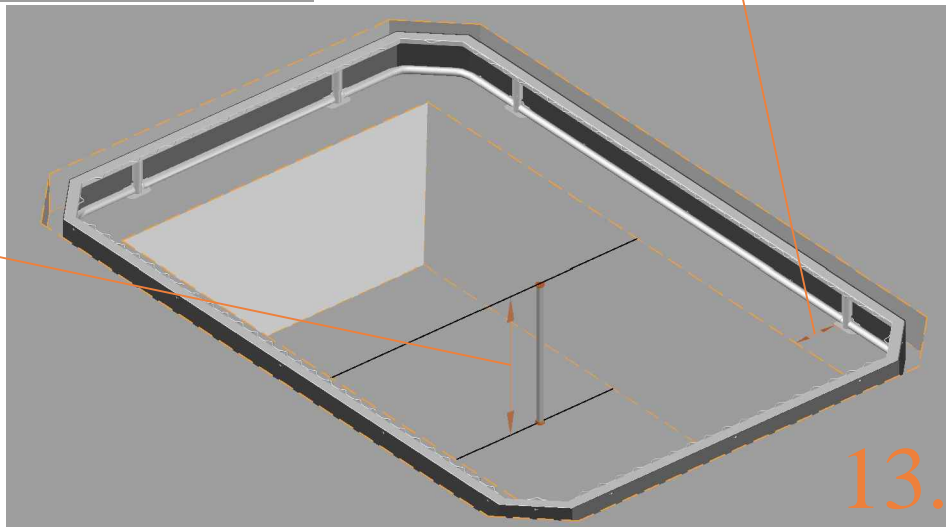

13.

14.

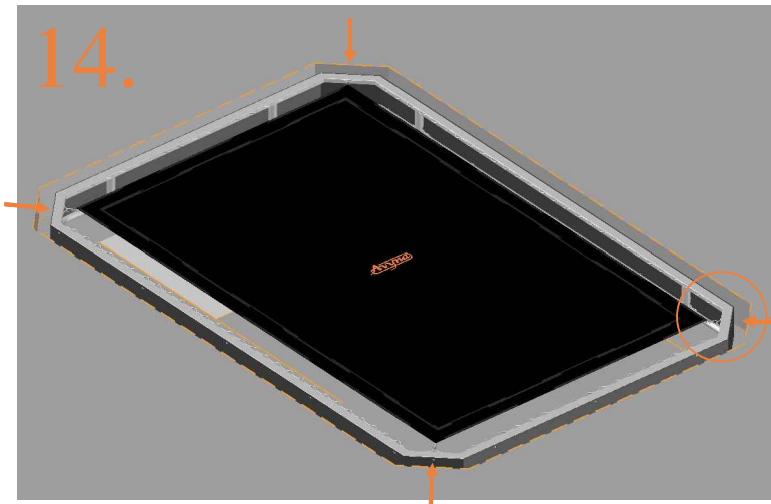

223-FL : 4x spring 140mm
234-FL / 238-FL : 4x spring 175mm

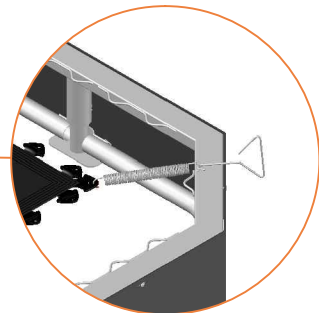

15.



16.

17.

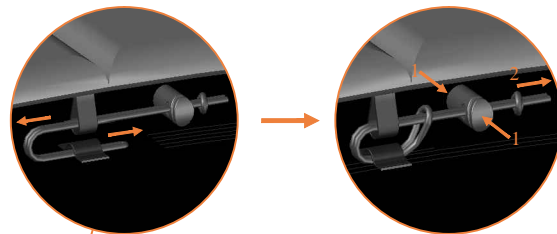
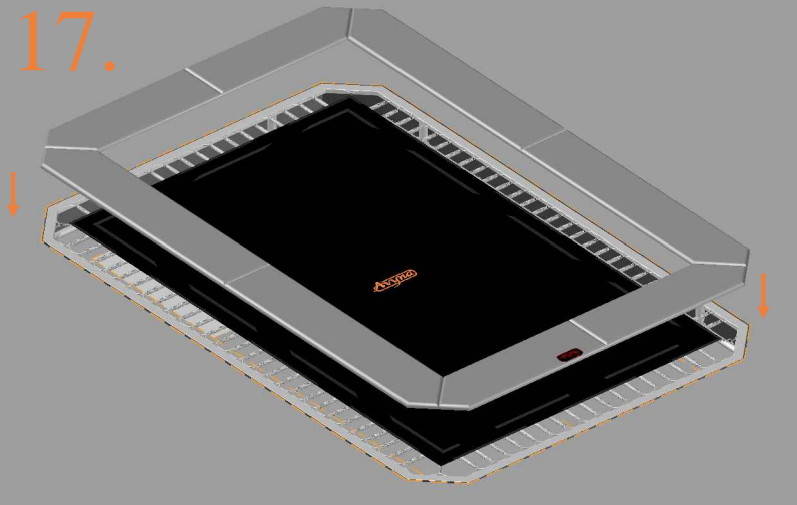

TEPL-ELAS-B

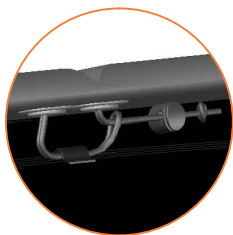

TEPL-ELAS-B

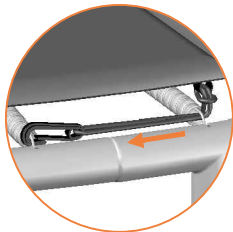



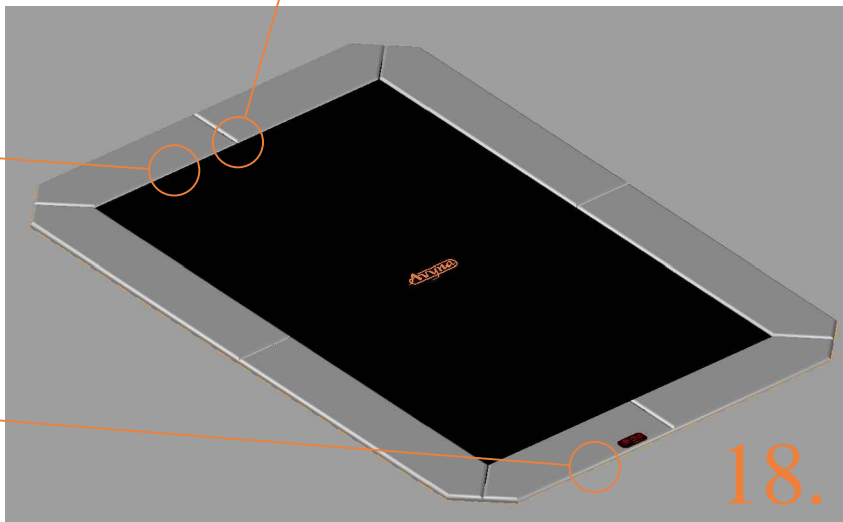

TEPL-ELAS-D

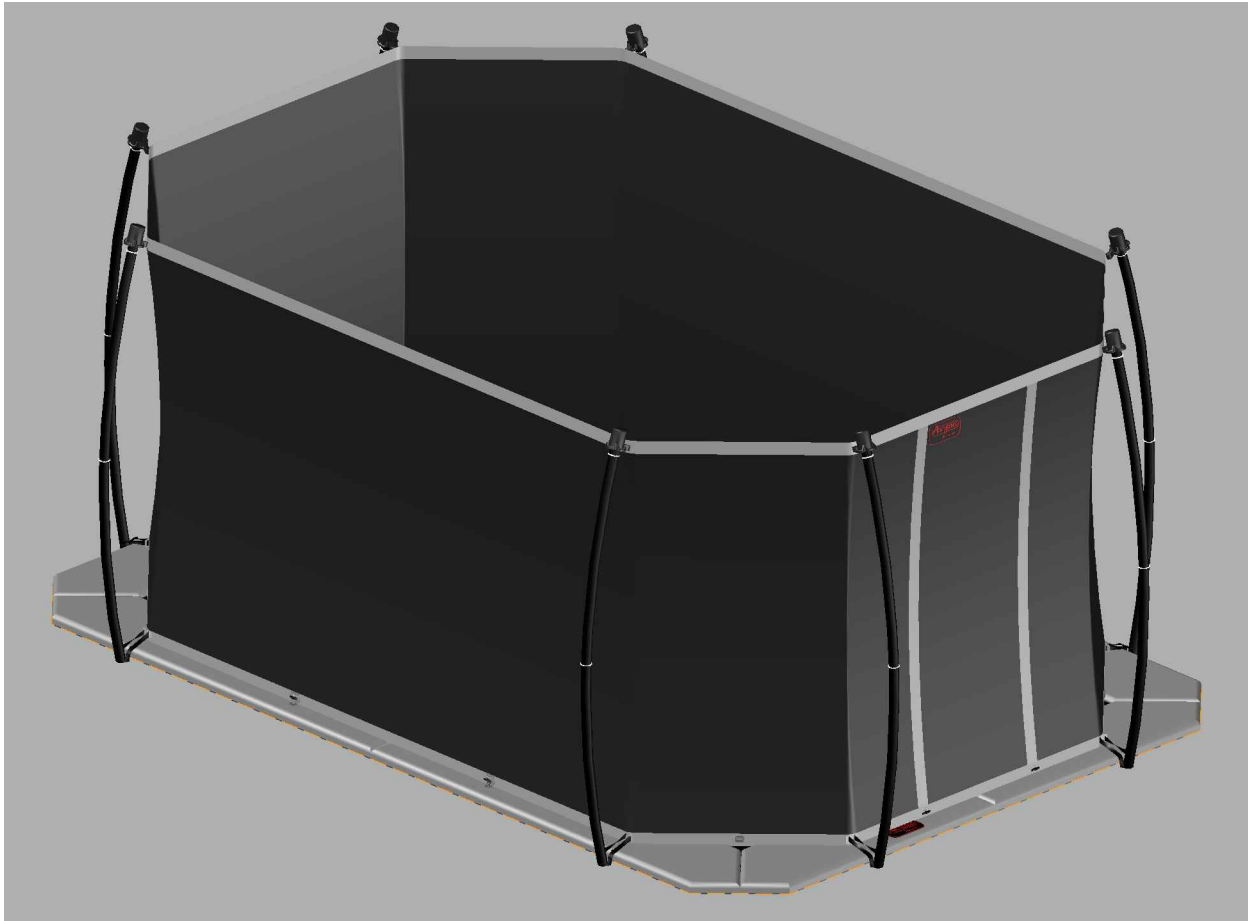

18.

Model 223-FL / Model 234-FL / Model 238-FL



		Model-223-FL APPROX 305x225cm		Model-234-FL APPROX 340x240cm		Model-238-FL APPROX 380x255cm	
		Quantity	Part number	Quantity	Part number	Quantity	Part number
Pole with sleeve for safety net		8	AVBL-223-FL-802 A	8	AVBL-234-FL-802 A	8	AVBL-238-FL-802 A
Pole for safety net		8	AVBL-223-FL-802 B	8	AVBL-234-FL-802 B	8	AVBL-238-FL-802 B
Clamp		8	CLAMP-TOOL-SN 223-FL	8	CLAMP-TOOL-SN 234-FL	8	CLAMP-TOOL-SN 238-FL
Screw M6x30		8	M6x30	8	M6x30	8	M6x30
Safety net		1	ANBL-223-FL	1	ANBL-234-FL	1	ANBL-238-FL
Straps for safety net		20	TEPL-BAND 16x short: 1,0m 4x long: 1,5m	20	TEPL-BAND 16x short: 1,0m 4x long: 1,5m	20	TEPL-BAND 16x short: 1,0m 4x long: 1,5m
Closure for safety net		2	TEPL-KNOOPJE	2	TEPL-KNOOPJE	2	TEPL-KNOOPJE
Fastening for safety net		10	TEPL-ELAS-C	10	TEPL-ELAS-C	10	TEPL-ELAS-C
Screw M8		16	M8-30	16	M8-30	16	M8-30
Allen key		2	ALLEN-KEY	2	ALLEN-KEY	2	ALLEN-KEY
Wrench		2	WRENCH	2	WRENCH	2	WRENCH

1.

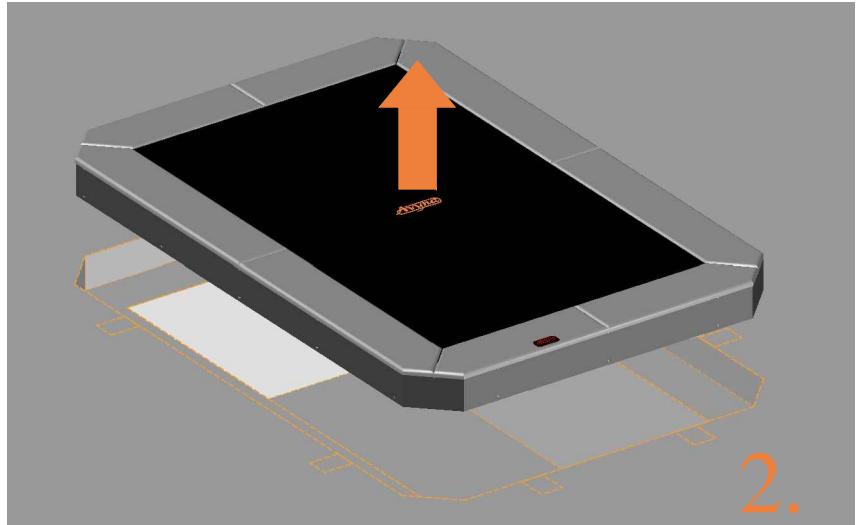
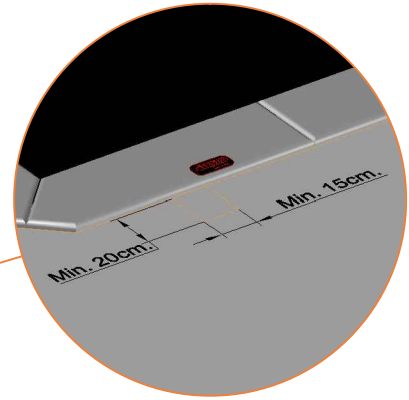
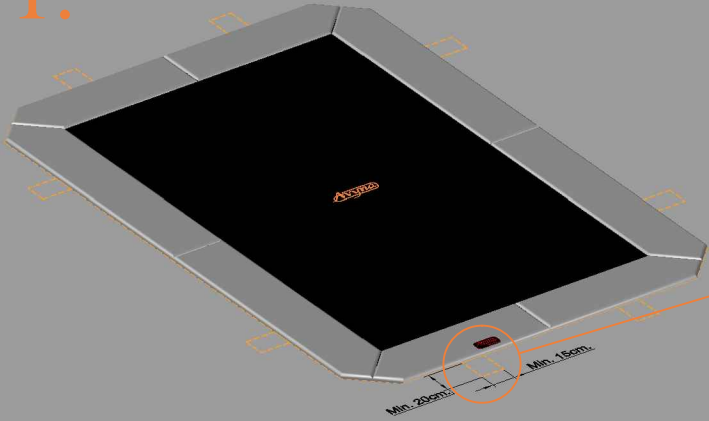

3.

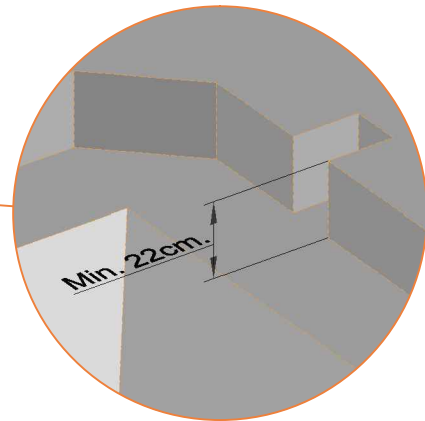
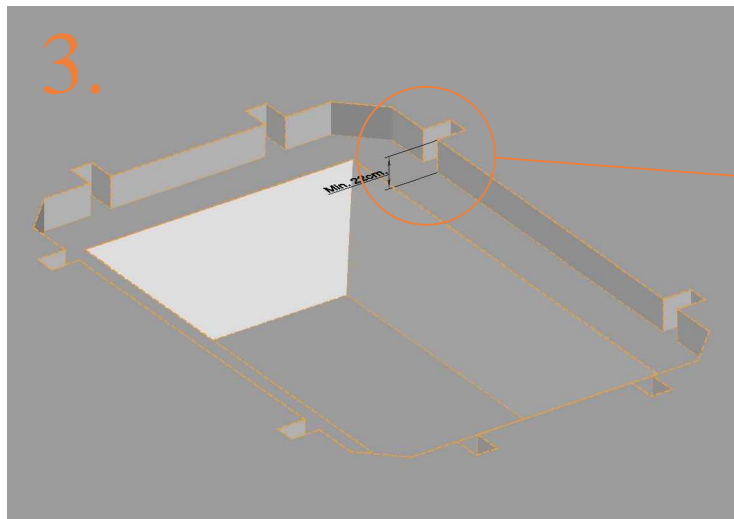

4.

5.

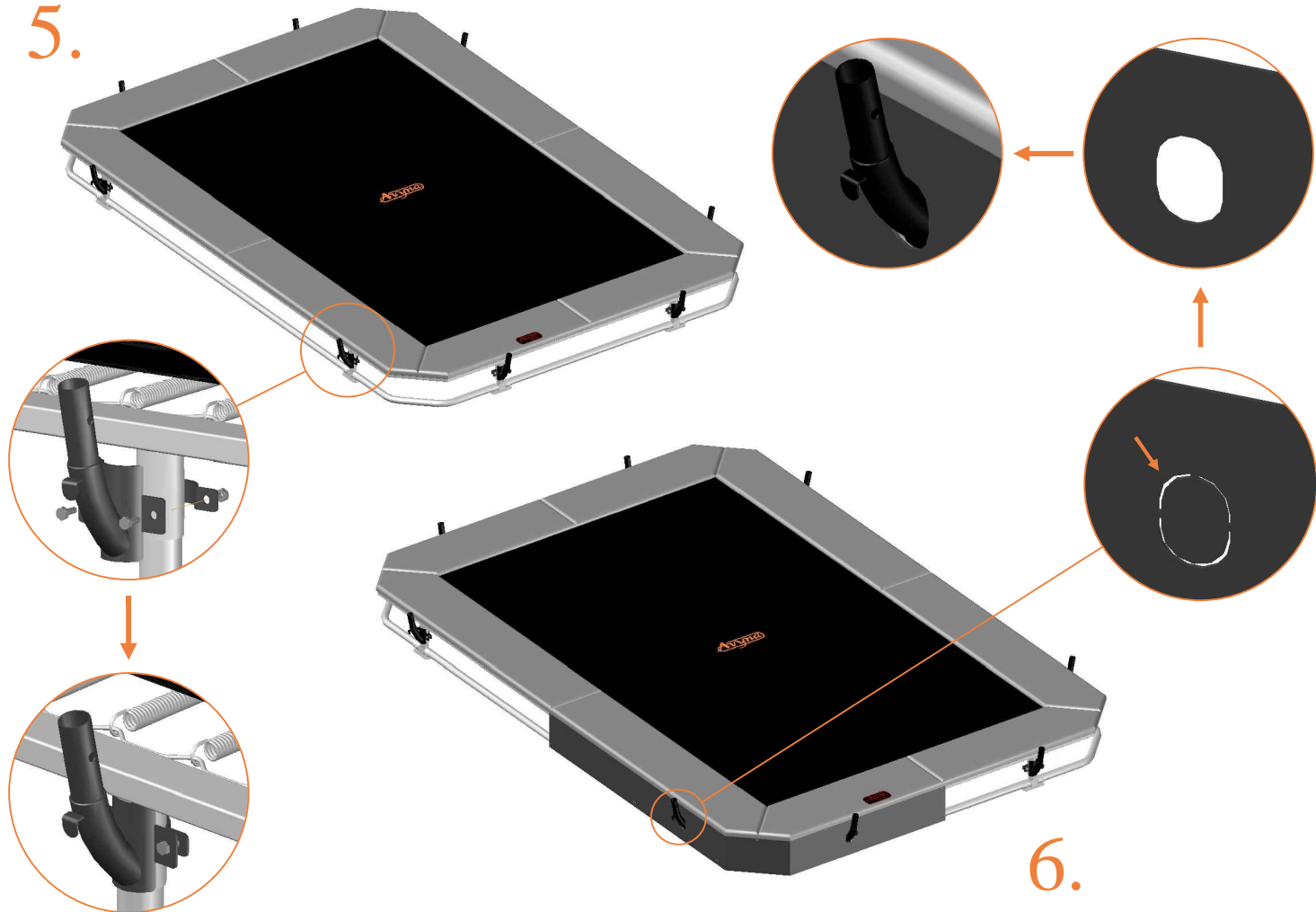

6.

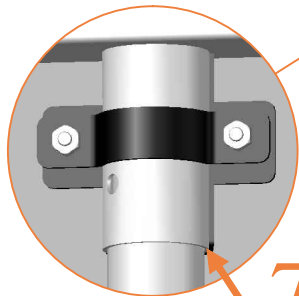
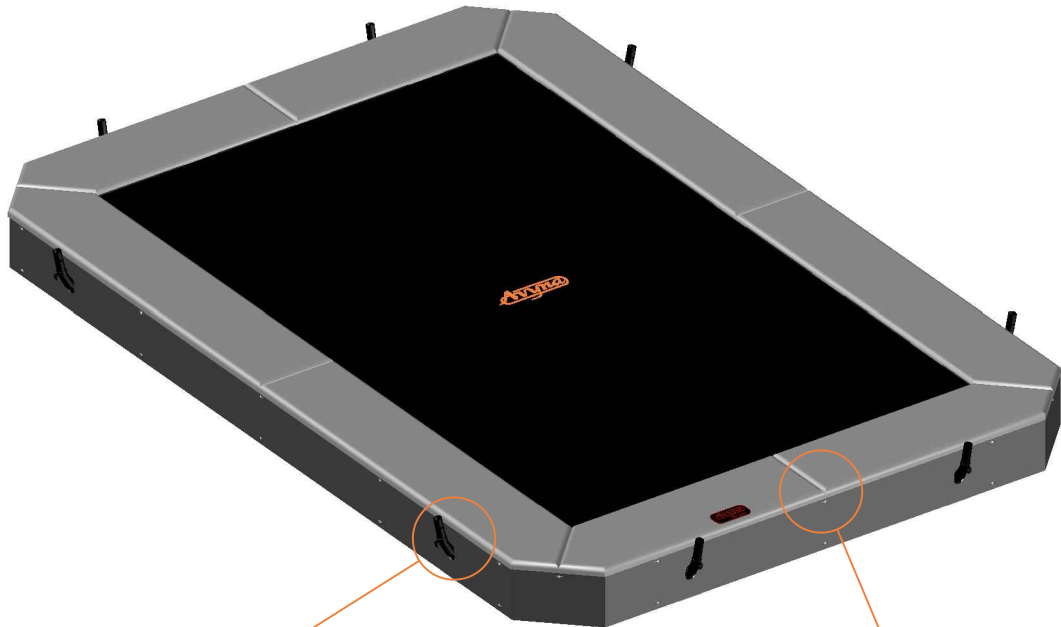

7.

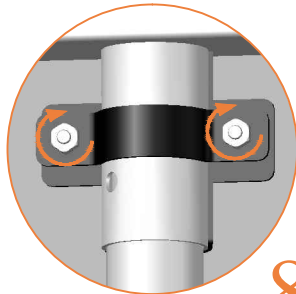

8.

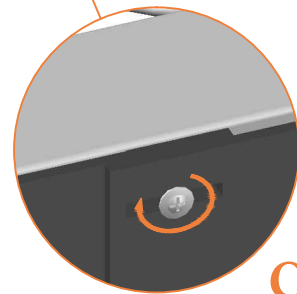

9.

10.

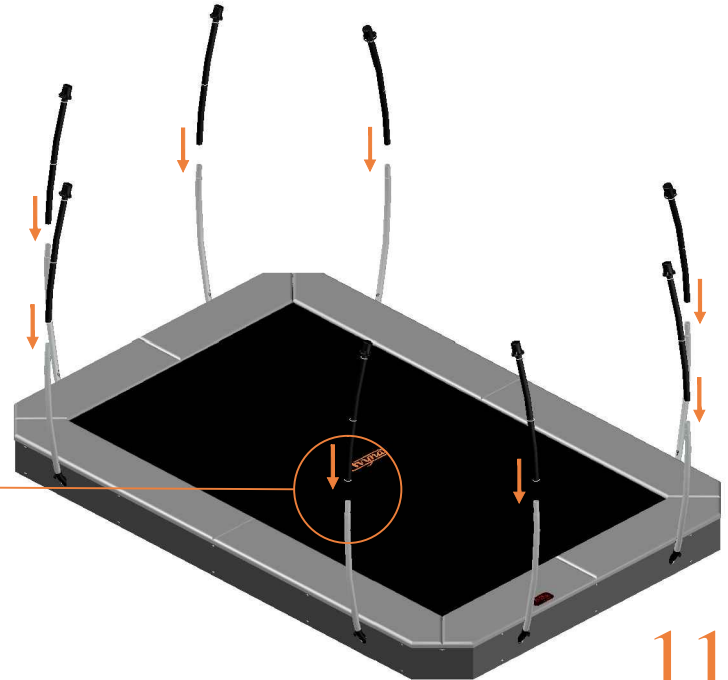
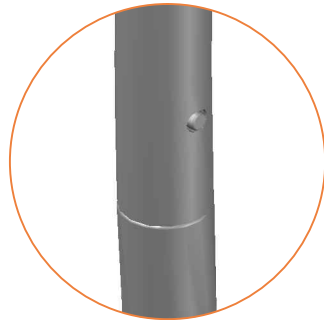
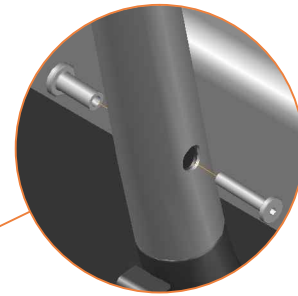
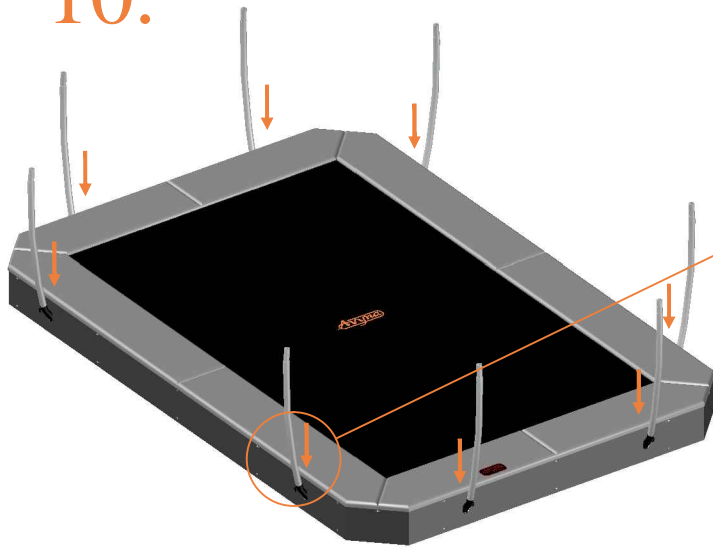

11.

12.

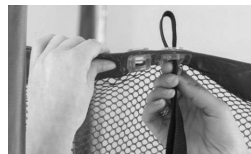

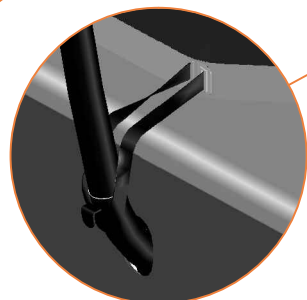
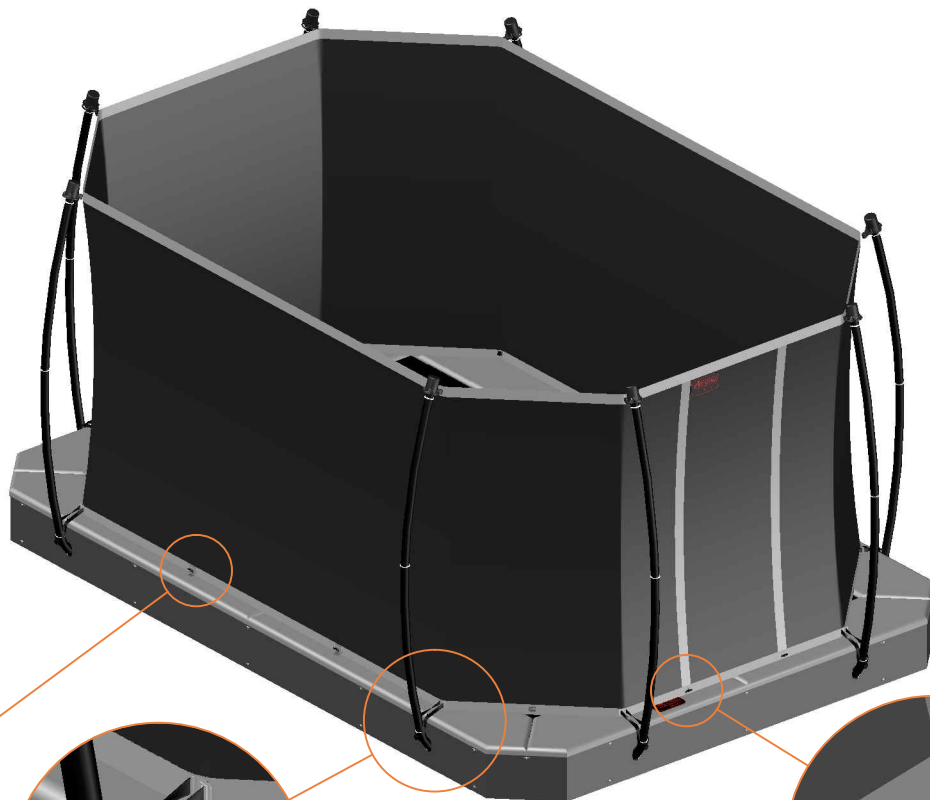
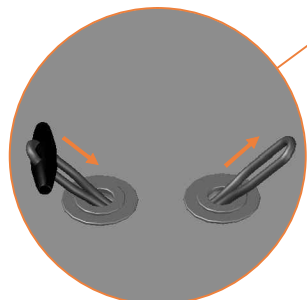
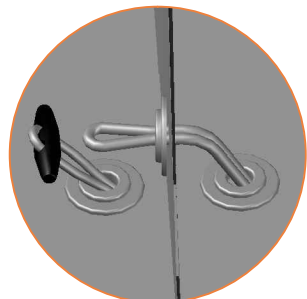

13.

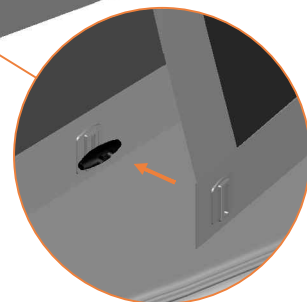

TEPL-ELAS-C

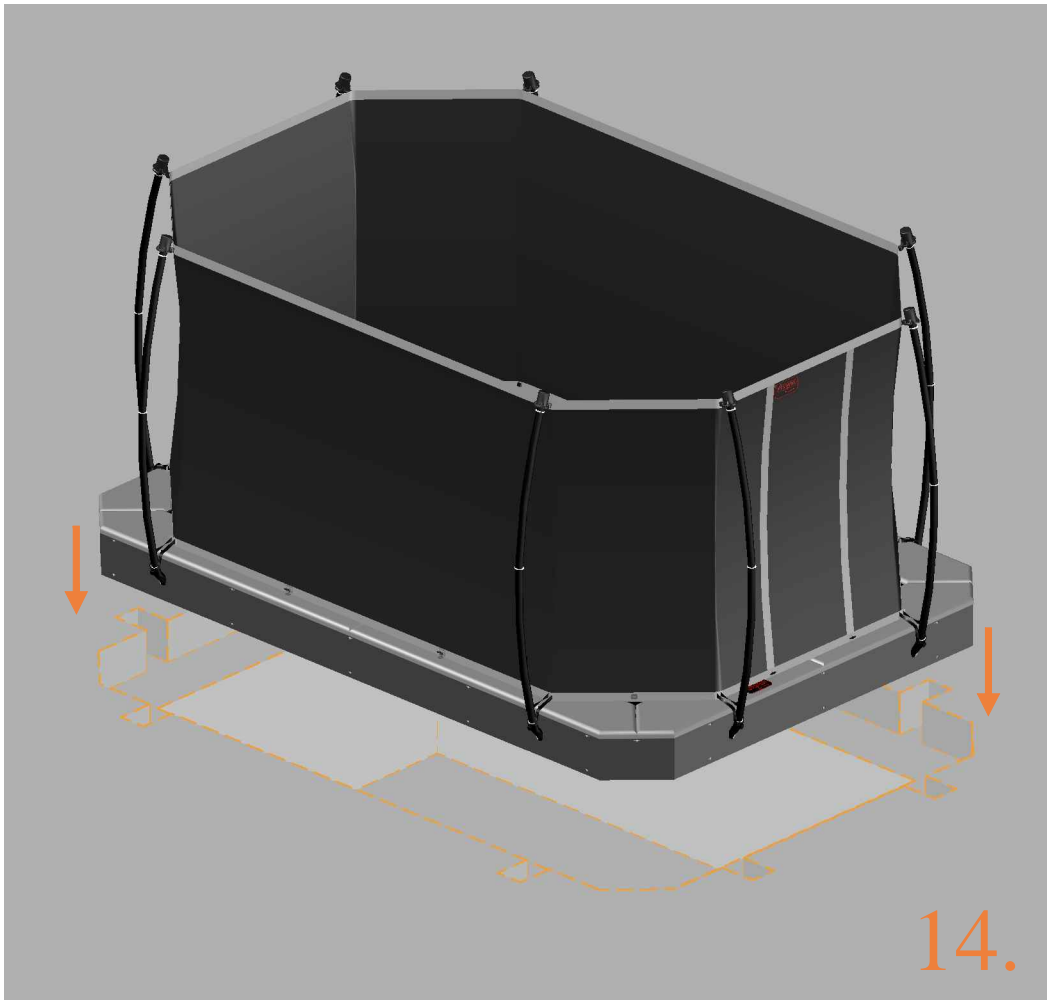

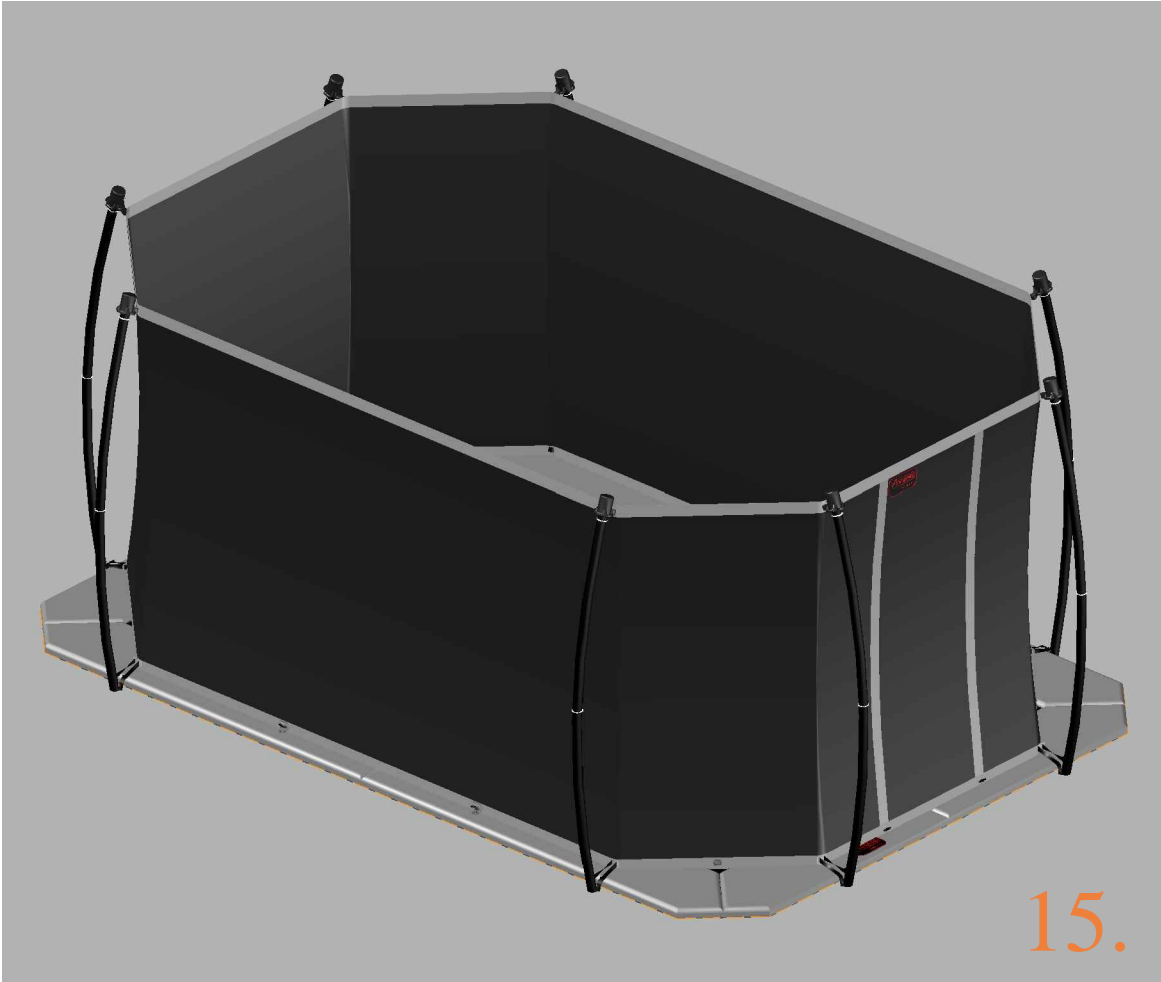

15.



Sales office: Beneluxbaan 7
5121 DC Rijen
The Netherlands
sales@avyna.eu
www.avyna.eu