



BERG FAVORIT

Productsheet XL



**BERG Favorit + Safety Net Comfort,
BERG Favorit InGround + Safety Net Comfort,
BERG Favorit InGround**

*Practice your
favorite jump!*

BERGTOYS.COM



WHY A FAVORIT?

The right balance between quality and price

Do you not get enough of jumping? No problem! The BERG Favorit provides years of pleasure, hardly wears and requires little maintenance. The BERG Favorit has been developed with great attention and care. This has resulted in a qualitatively excellent trampoline, which is safe to use.

In this productsheet you can find information about:

1. The round shape
2. The protective edge
3. The jump mat
4. The springs
5. The frame
6. The Safety Net Comfort

WARRANTY

Frame: 8 years*

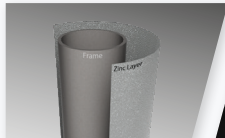

Protective edge: 2 years

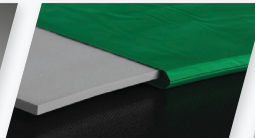

Jumping mat: 2 years



Springs: 2 years



* On registration at bergtoys.com/registration

In this productsheet: Model, size and colour subject to change. Printing and typesetting errors reserved.



BERGTOYS.COM



1. THE ROUND SHAPE

The frame of a round trampoline is very strong. On a round trampoline you always jump towards the centre. The best jumps are made in the centre of a round trampoline. This is because the tension on the springs and the frame is equally divided when jumping.

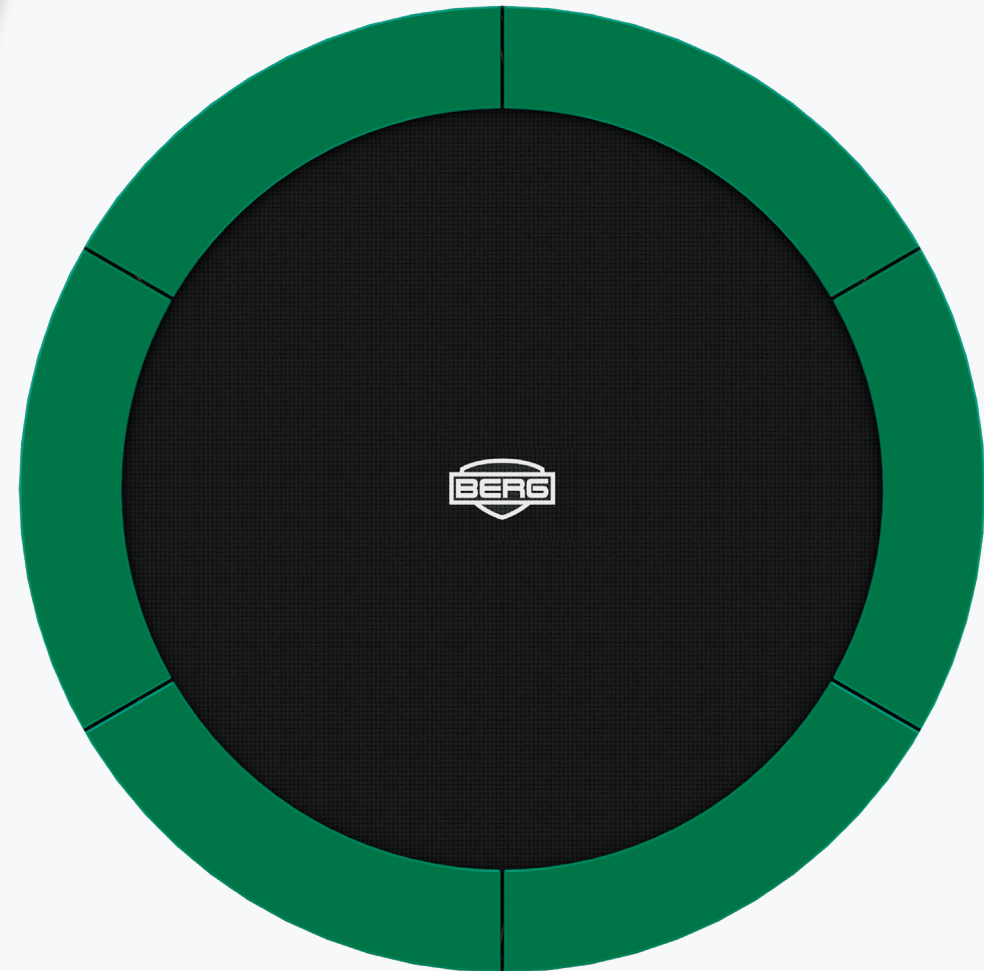



2. PROTECTIVE EDGE

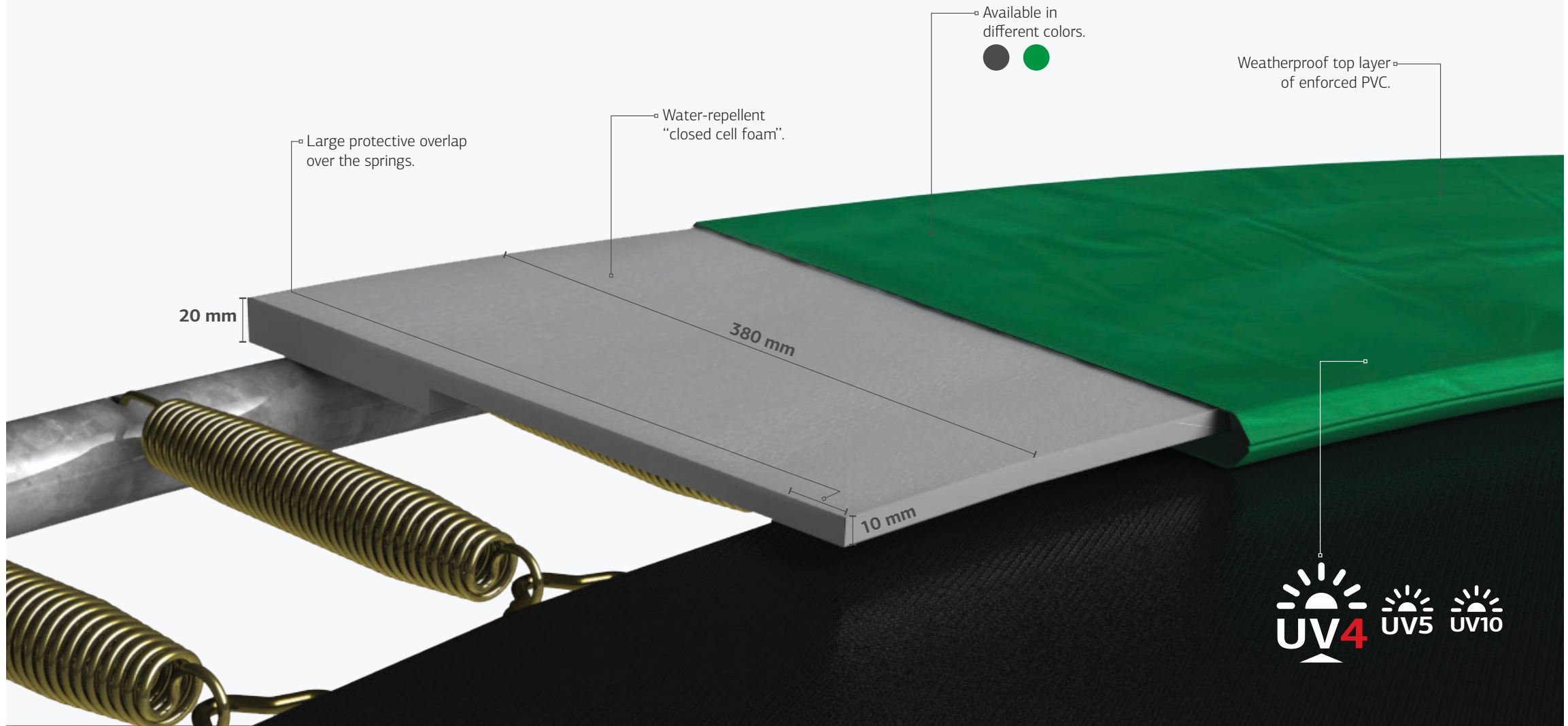



3. THE JUMP MAT

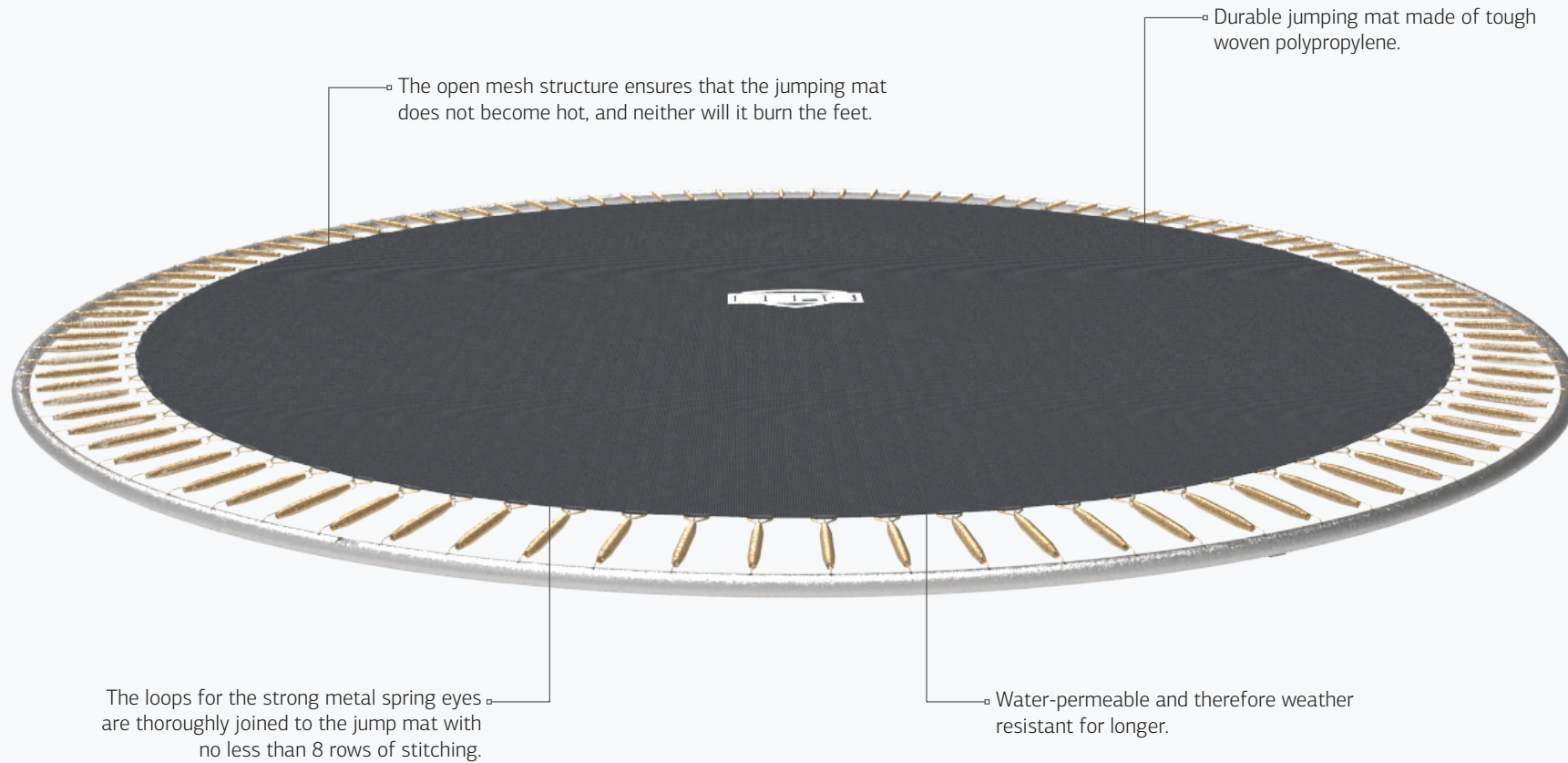



4. GOLDSRING SOLO

All sizes of the Favorit line are equipped with these springs. That's why you can make nice jumps on all these trampolines. The jumping comfort of these trampolines is much higher compared to the earlier BERG Talent line with GoldSpring Talent springs.

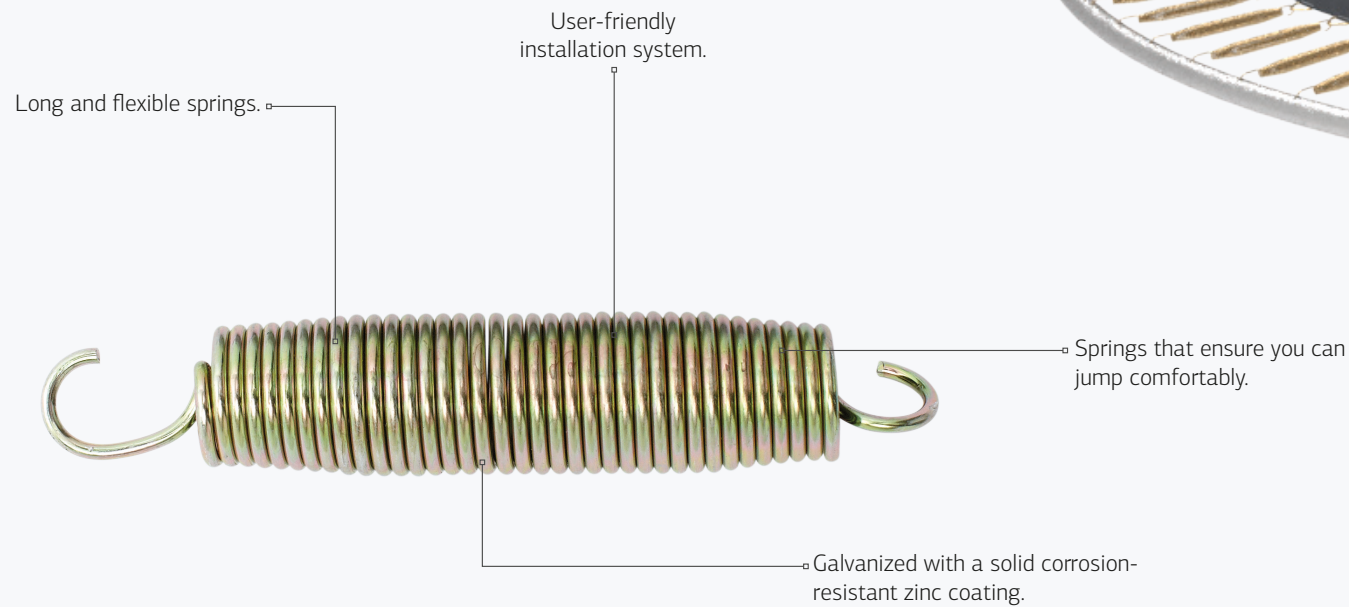
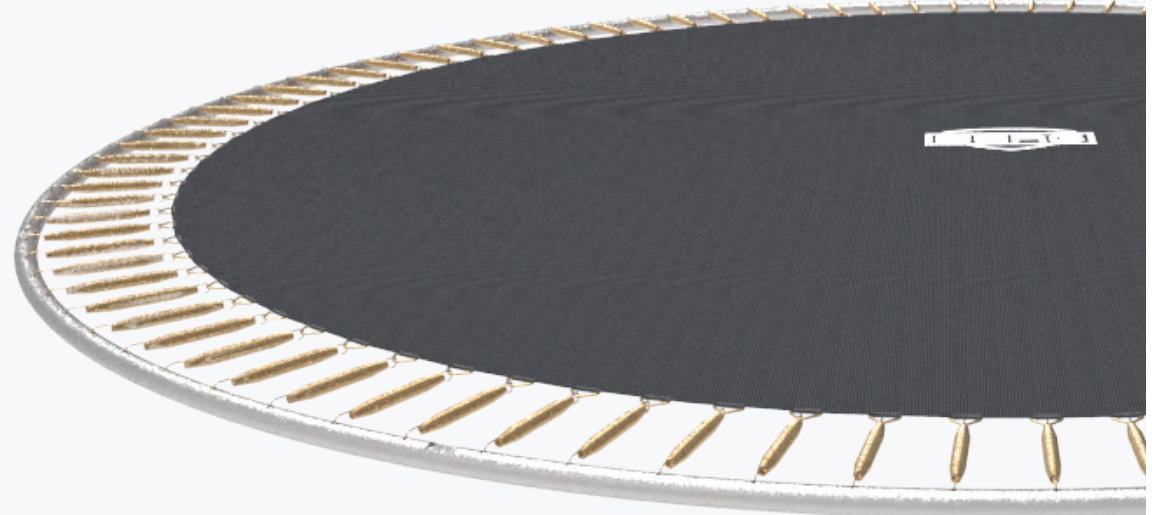



5. FRAME

The frame of the Favorit consists of thick, large diameter tubes. As a result, the Favorit trampoline has a long service life. The frame is rustproof due to its durable layer of zinc. The frame is easy to assemble.

The frames of sizes 200, 270 and 330 have 6 legs. The frames of sizes 380 and 430 have 8 legs. Please refer to the table at the back of this product sheet for all tube diameters and step-on heights.

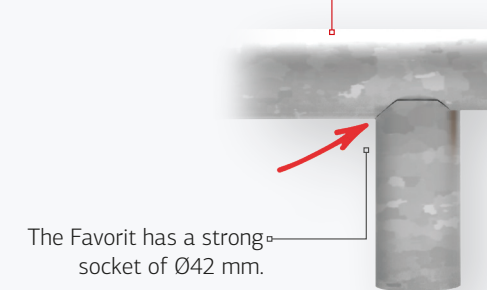
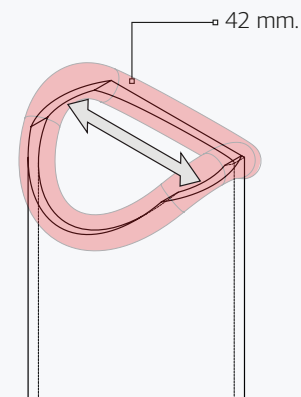
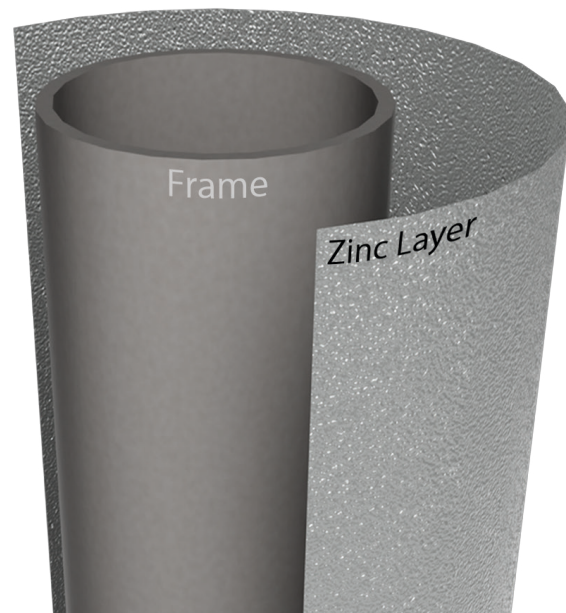



6. SAFETY NET COMFORT



* This new top cap can be used for the old and the new Safety Net Comfort.



BERG FAVORIT

The right balance between quality and price

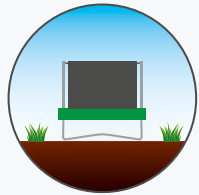

BERG Regular + Safety Net ● ●

If you prefer not to dig a hole in your garden, a high trampoline is a good choice. A high trampoline is easy to install and move around. A high trampoline is also clearly visible in your garden.

Ø 200 and 270 not in green

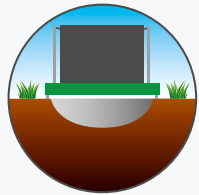

BERG InGround + Safety Net ● ●

A sunken trampoline with a safety net has a low threshold, making it easy and safe to step onto. The InGround trampoline is less visible in the garden than a high trampoline.

Ø 200 and 270 not in green

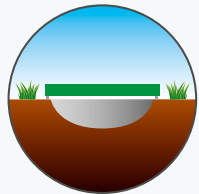

BERG InGround (Sports) ● ● **SPORTS**

The sunken trampoline without safety net (sports) is nicely concealed in your garden. The low threshold of 20 centimetres makes the trampoline easy and safe to step onto.

Ø 200 and 270 not in green





BERG FAVORIT

The right balance between quality and price



Article number	EAN - Code	Product name	Package 1	Package 2	Number of springs	Entrance height in cm	Test-weight in kg	Max user weight in kg	Padding thickness in mm	Width padding in mm	Total height trampoline in cm	Safety Net height in cm
35.07.33.00	8715839070903	BERG Favorit Regular 200 Grey + Safety Net Comfort	-	-	36	60	250	50	20/10	380	210	150
35.09.33.00	8715839070910	BERG Favorit Regular 270 Grey + Safety Net Comfort	-	-	48	70	350	70	20/10	380	250	180
35.11.33.00	8715839070934	BERG Favorit Regular 330 Grey + Safety Net Comfort	-	-	72	85	500	100	20/10	380	265	180
35.11.37.00	8715839070927	BERG Favorit Regular 330 Green + Safety Net Comfort	-	-	72	85	500	100	20/10	380	265	180
35.12.94.01	8715839071115	BERG Favorit Regular 380 Grey + Safety Net Comfort	35.12.13.00	35.74.12.03	80	90	550	110	20/10	380	270	180
35.12.01.03	8715839071108	BERG Favorit Regular 380 Green + Safety Net Comfort	35.12.07.06	35.74.12.03	80	90	550	110	20/10	380	270	180
35.14.94.01	8715839071184	BERG Favorit Regular 430 Grey + Safety Net Comfort	35.14.13.00	35.74.14.03	96	90	600	120	20/10	380	270	180
35.14.02.03	8715839071177	BERG Favorit Regular 430 Green + Safety Net Comfort	35.14.07.06	35.74.14.03	96	90	600	120	20/10	380	270	180
35.14.99.01	8715839071207	BERG Favorit Regular 430 Grey Levels + Safety Net Comfort	35.14.14.00	35.74.14.03	96	90	600	120	20/10	380	270	180



BERG FAVORIT

The right balance between quality and price



Article number	EAN - Code	Product name	Package 1	Package 2	Number of springs	Entrance height in cm	Test-weight in kg	Max user weight in kg	Padding thickness in mm	Width padding in mm	Total height trampoline in cm	Safety Net height in cm
35.07.23.00	8715839071030	BERG Favorit InGround 200 Grey + Safety Net Comfort	35.07.53.00	35.74.40.00	36	20	250	50	20/10	380	170	150
35.09.23.00	8715839071047	BERG Favorit InGround 270 Grey + Safety Net Comfort	35.09.53.00	35.74.41.00	48	20	350	70	20/10	380	200	180
35.11.23.00	8715839071061	BERG Favorit InGround 330 Grey + Safety Net Comfort	35.11.53.00	35.74.42.00	72	20	500	100	20/10	380	200	180
35.11.27.00	8715839071054	BERG Favorit InGround 330 Green + Safety Net Comfort	35.11.57.00	35.74.42.00	72	20	500	100	20/10	380	200	180
35.12.92.01	8715839071085	BERG Favorit InGround 380 Grey + Safety Net Comfort	35.12.43.00	35.74.12.03	80	20	550	110	20/10	380	200	180
35.12.04.02	8715839071078	BERG Favorit InGround 380 Green + Safety Net Comfort	35.12.47.02	35.74.12.03	80	20	550	110	20/10	380	200	180
35.14.92.01	8715839071153	BERG Favorit InGround 430 Grey + Safety Net Comfort	35.14.43.00	35.74.14.03	96	20	600	120	20/10	380	200	180
35.14.09.02	8715839071139	BERG Favorit InGround 430 Green + Safety Net Comfort	35.14.47.02	35.74.14.03	96	20	600	120	20/10	380	200	180



BERG FAVORIT

The right balance between quality and price

SPORTS



Article number	EAN - Code	Product name	Number of springs	Entrance height in cm	Test-weight in kg	Max user weight in kg	Padding thickness in mm	Width padding in mm	Total height trampoline in cm	Safety Net height in cm
35.07.53.00	8715839070842	BERG Favorit InGround 200 Grey	36	20	250	50	20/10	380	20	-
35.09.53.00	8715839070859	BERG Favorit InGround 270 Grey	48	20	350	70	20/10	380	20	-
35.11.53.00	8715839070873	BERG Favorit InGround 330 Grey	72	20	500	100	20/10	380	20	-
35.11.57.02	8715839070866	BERG Favorit InGround 330 Green	72	20	500	100	20/10	380	20	-
35.12.43.00	8715839062069	BERG Favorit InGround 380 Grey	80	20	550	110	20/10	380	20	-
35.12.47.02	8715839052114	BERG Favorit InGround 380 Green	80	20	550	110	20/10	380	20	-
35.14.43.00	8715839062076	BERG Favorit InGround 430 Grey	96	20	600	120	20/10	380	20	-
35.14.47.02	8715839052121	BERG Favorit InGround 430 Green	96	20	600	120	20/10	380	20	-



BERG FAVORIT ACCESSORIES

The right balance between quality and price

Accessory	Article	Product weight	Product weight + box	Box size in cm
1 BERG Weather Cover Extra 200 Grey	35.99.61.00	2.7 kg	3.3 kg	57x10x28
2 BERG Weather Cover Extra 270 Grey	35.99.62.00	4.6 kg	5.2 kg	57x11x38
3 BERG Weather Cover Extra 270 Green	35.99.52.02	4.6 kg	5.2 kg	58x11x38
4 BERG Weather Cover Extra 330 Grey	35.99.63.00	6 kg	6.7 kg	58x12x38
5 BERG Weather Cover Extra 330 Green	35.99.53.02	6 kg	6.7 kg	58x12x38
6 BERG Weather Cover Extra 380 Grey	35.99.64.00	7.1 kg	8 kg	58x16x38
7 BERG Weather Cover Extra 380 Green	35.99.54.02	7.1 kg	8 kg	58x16x38
8 BERG Weather Cover Extra 430 Grey	35.99.65.00	8.9 kg	10 kg	58x19x38
9 BERG Weather Cover Extra 430 Green	35.99.55.02	8.9 kg	10 kg	58x19x38

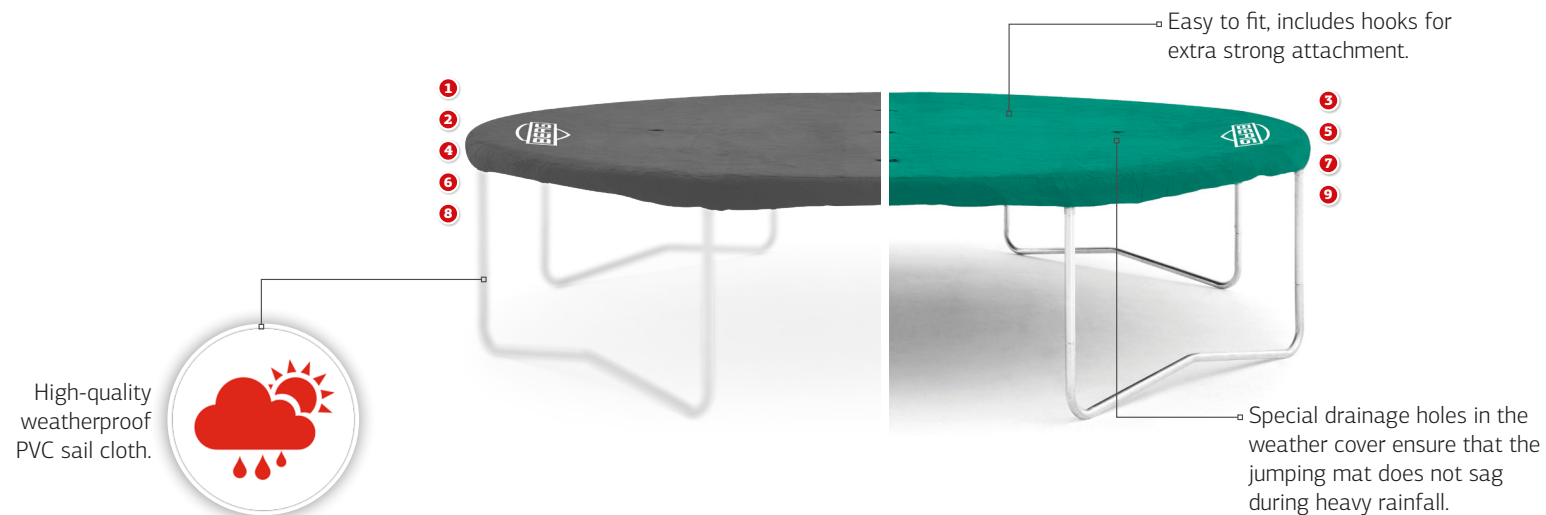



BERG FAVORIT ACCESSORIES

The right balance between quality and price

Accessory	Article	Package 1	Package 2	Product weight	Product weight + box	Box size in cm
1 BERG Ladder M*	35.90.05.01	-	-	2.4 kg	3 kg	68x6x24
2 BERG Ladder L**	35.90.04.00	-	-	2.7 kg	3.4 kg	84x6x24
3 BERG Ladder Platform + Ladder M*	35.90.55.01	35.90.05.01	35.90.03.00	5.2 kg	6.9 kg	56x14x54 + 24x68x6
4 BERG Ladder Platform + Ladder L**	35.90.54.00	35.90.04.00	35.90.03.00	5.5 kg	7.3 kg	56x14x54 + 24x84x6

* For trampolines measuring 60 and 70 cm high. The ladder is height adjustable.

** For trampolines measuring 85, 90 and 95 cm high. The ladder is height adjustable.





BERG FAVORIT ACCESSORIES

The right balance between quality and price

Accessory	Article	Product weight	Product weight + box	Box size in cm
1 BERG Anchor set	35.99.10.00	1.4 kg	1.5 kg	30x10x10



Secure your trampoline more firmly with this anchor set for even more safety.





BERG FAVORIT ACCESSORIES

The right balance between quality and price

Accessory	Article	Product weight	Product weight + box	Box size in cm
1 BERG Framenet Extra 380	35.80.12.01	3.2 kg	3.6 kg	29.5x15x32
2 BERG Framenet Extra 430	35.80.14.01	3.7 kg	4.2 kg	29.5x18x32





BERGTOYS.COM