



BERG GRAND CHAMPION

Productsheet XL



BERG Grand Champion + Safety Net,
BERG Grand Champion InGround + Safety Net,
BERG Grand Champion InGround

Become a **champion**
on our largest
oval trampoline

BERGTOYS.COM



WHY A GRAND CHAMPION?

Choose the unbeaten Champion!

The BERG Grand Champion has been developed with great attention and care. This resulted in a qualitative excellent trampoline, which is safe to use. It does not matter which one you choose, you choose quality with a BERG Grand Champion. The BERG Grand Champion is cleverly designed for long and safe jumping. The combination of the TwinSpring Gold springs and the AirFlow jumping technique ensures less air resistance, a larger jump area and more jumping fun!

In this productsheet you can find information about:

1. The oval shape
2. The protective edge
3. The jump mat
4. The springs
5. The frame
6. The Safety Net Deluxe
7. The Safety Net DLX XL

WARRANTY

Frame: 13 years*

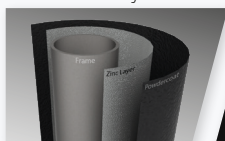

Protective edge: 2 years

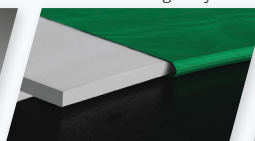

Jumping mat: 2 years



Springs: 5 years

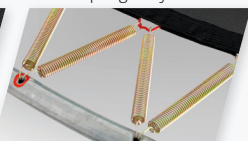

* On registration at bergtoys.com/registration

In this productsheet: Model, size and colour subject to change. Printing and typesetting errors reserved.

BERGTOYS.COM





1. THE OVAL SHAPE

The oval shape combines the efficient strength of a round frame with the large jumping surface of a rectangular trampoline. On an oval trampoline you can make some nice jumps over the entire length.

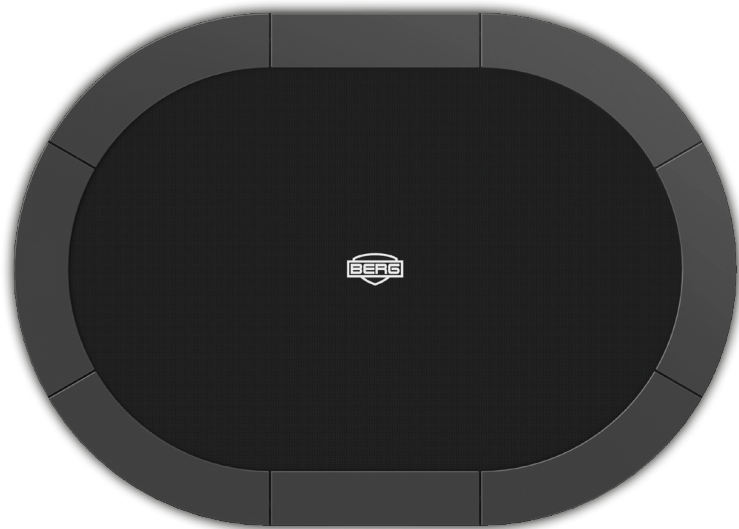



2. PROTECTIVE EDGE

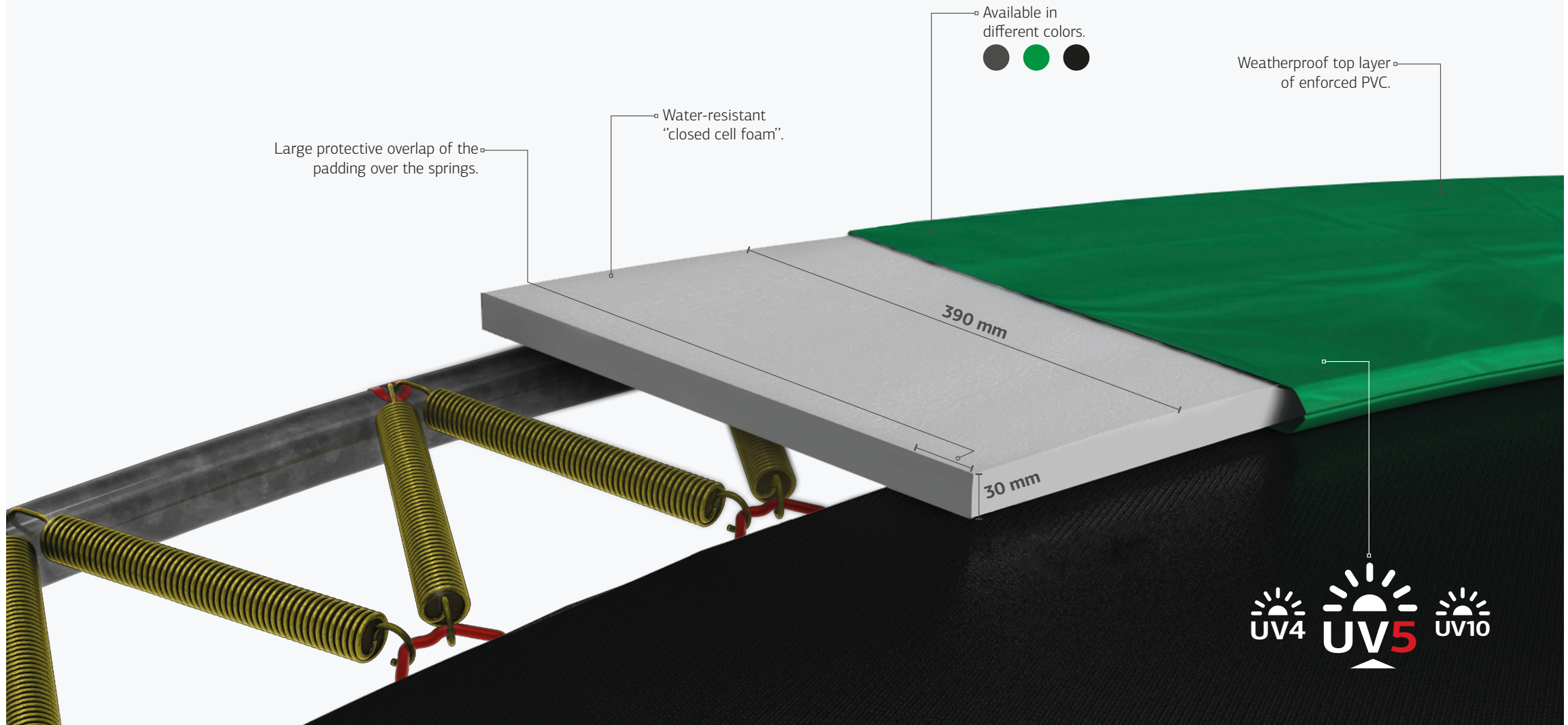



3. AIRFLOW

Higher jumps mean more fun. We have developed the AirFlow technique to enable you to make higher jumps. This jumping mat allows 50% more air permeation compared with a standard jumping mat. Good AirFlow ensures less resistance while jumping, which is why you can make higher jumps.

The durable AirFlow jump mat is made from woven polypropylene. The jump mat contains special spring-eyes for the TwinSpring system. The loops for the strong metal spring eyes are thoroughly joined to the jump mat with no less than 8 rows of stitching.



POWERED BY
AIRFLOW
& TWINSRING

The AirFlow product innovation is only available on the BERG Champion and BERG Elite lines.

50% more air permeation for better jumping comfort.



AIRFLOW
Higher & more flexible jumping.



BERGTOYS.COM



4. TWINSRING GOLD

The perfect jump area is that optimal part of the jump mat which results in the best jump experience. Jumping outside of this area results in a sense of feeling as if you are being pushed towards the inner part of the trampoline. Trampolines comprising of TwinSpring Gold Springs are mounted in the shape of a "V". This allows for larger perfect jump area compared to trampolines that are sold with a conventional spring.

Another advantage? Due to the angled positioning of the TwinSpring Gold, the springs are longer in length without compromising the size of the jump mat. This results in a safer trampoline that optimizes playing pleasure!

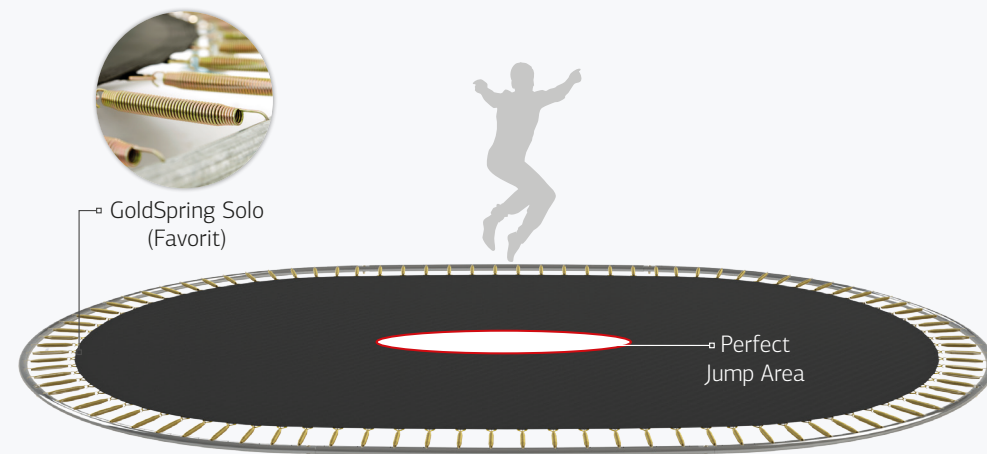
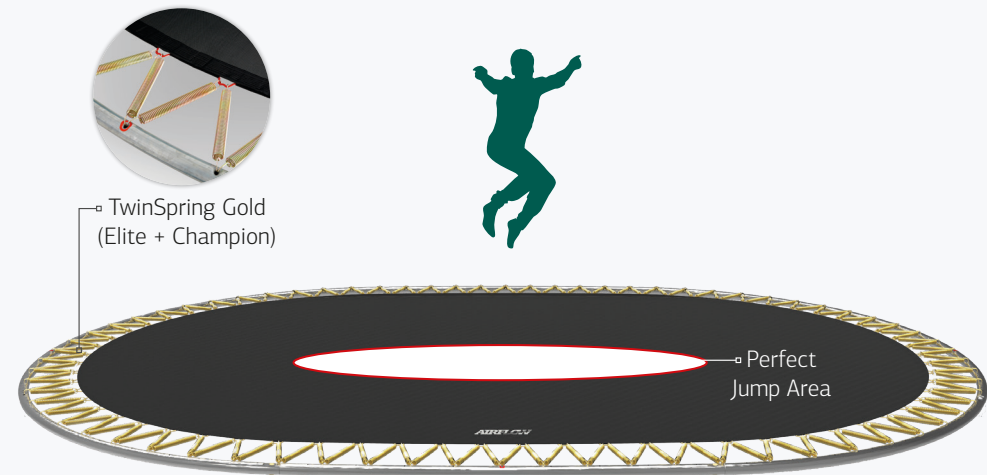
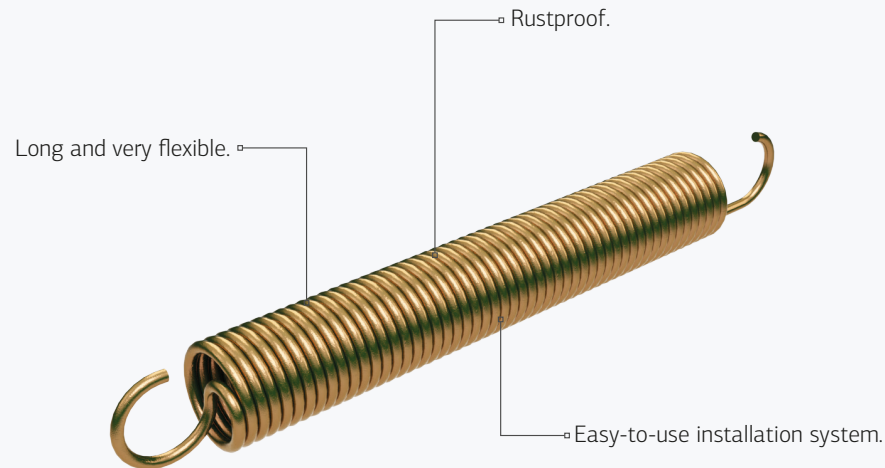



5. FRAME

The Grand Champion has a solid frame of strong tubes with a substantial tube thickness. The frame is highly rust-resistant caused by the special double coating on the tube. The tubes are first provided with a durable zinc-layer and then covered with a beautiful black powder coating layer. The frame is easy to assemble.

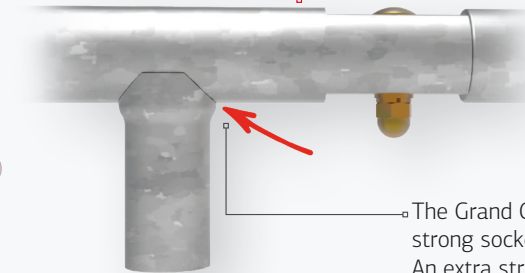
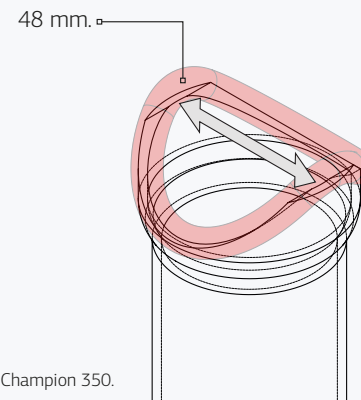
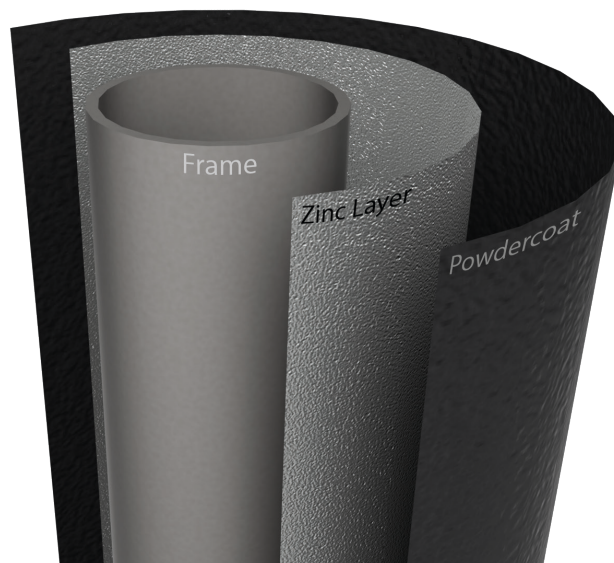

The Grand Champion has a strong socket of $\varnothing 48$ mm*. An extra strong weld seam is used for this socket.

* Except for the Grand Champion 350.



6. SAFETY NET DELUXE

Thanks to the reinforced upper edge (made of fibreglass poles), the Safety Net is always nice and taut.

Extremely safe, self-closing entrance with distinctive trim.

The top caps of this trampoline connect the hoop to the poles. The caps have an easy click system and are therefore easy to attach.*

Foam padding around the Safety Net poles provides extra protection.

The curved poles provide extra safety by creating distance between the Safety Net and the pole.

The Safety Net is extra safe and easy to use by leaving space between the edge of the net and the edge of the trampoline, for easy access to the trampoline.



The poles are equipped with solid clamps that are easy to assemble.

High-quality, dimensionally stable netting that feels soft to the touch.

Having the net attached to the outer edge of the padding creates a larger jumping surface.



* This new top cap can be used for the old and the new Safety Net Deluxe.



7. SAFETY NET DLX XL*

The Safety Net Deluxe XL is extra high (220 cm). This makes the net extra safe. The high opening makes it easy to access the trampoline.

22% XL

HIGHER & SAFER

The pole sleeve has a long split that can be closed with a strip of Velcro.

Extra safe due to the thick layer of foam around the Safety Net poles.



The poles are equipped with sturdy clamps that are easy to assemble.

Extremely safe, self-closing entrance with distinctive trim.

Having the net attached to the outer edge of the padding creates a larger jumping surface.

Thanks to the reinforced upper edge (made of fibreglass poles), the Safety Net is always nice and taut.



The top caps of this trampoline connect the hoop to the poles. The caps have an easy click system and are therefore easy to attach.

The robust, curved poles provide more space between the Safety Net and the pole and therefore provide extra safety.

High-quality, dimensionally stable netting that feels soft to the touch.

The Safety Net is extra safe and easy to use by leaving space between the edge of the net and the edge of the trampoline, for easy access to the trampoline.



* Only available on size 520.



BERG GRAND CHAMPION

Choose the unbeaten Champion!

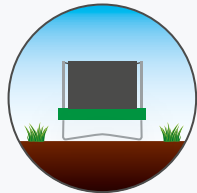

BERG Regular + Safety Net ● ● ●

If you prefer not to dig a hole in your garden, a high trampoline is a good choice. A high trampoline is easy to install and move around. A high trampoline is also clearly visible in your garden.

Ø 350 and Ø 470 not in black and grey

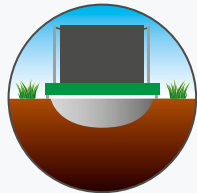

BERG InGround + Safety Net ● ● ●

A sunken trampoline with a safety net has a low threshold, making it easy and safe to step onto. The InGround trampoline is less visible in the garden than a high trampoline.

Ø 350 and Ø 470 not in black and grey

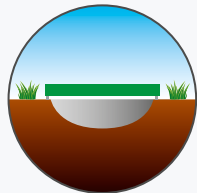

BERG InGround (Sports) ● ● ● **SPORTS**

The sunken trampoline without safety net (sports) is nicely concealed in your garden. The low threshold of 27 centimetres makes the trampoline easy and safe to step onto.

Ø 350 and Ø 470 not in black and grey





BERG GRAND CHAMPION

Choose the unbeaten Champion!



Article number	EAN - Code	Product name	Package 1	Package 2	Package 3	Number of springs	Entrance height in cm	Test-weight in kg	Max user weight in kg	Padding thickness in mm	Width padding in mm	Total height trampoline in cm	Safety Net height in cm
30.35.73.71	8715839071801	BERG Grand Champion Regular 350 Green + Safety Net Deluxe	30.35.13.70	35.72.64.01	-	80	85	550	110	30	390	265	180
30.35.74.71	8715839071818	BERG Grand Champion Regular 470 Green + Safety Net Deluxe	30.35.14.70	35.72.65.01	-	112	95	600	120	30	390	270	180
30.35.75.31	8715839071825	BERG Grand Champion Regular 520 Grey + Safety Net Deluxe	30.35.15.30	30.99.15.90	35.72.63.02	144	95	600	120	30	390	275	180
30.35.95.30	8715839072402	BERG Grand Champion Regular 520 Grey + Safety Net DLX XL	30.35.15.30	30.99.15.90	35.76.05.00	144	95	600	120	30	390	315	220
30.35.75.71	8715839071832	BERG Grand Champion Regular 520 Green + Safety Net Deluxe	30.35.15.70	30.99.15.90	35.72.63.02	144	95	600	120	30	390	275	180
30.35.95.70	8715839072419	BERG Grand Champion Regular 520 Green + Safety Net DLX XL	30.35.15.70	30.99.15.90	35.76.05.00	144	95	600	120	30	390	315	220
30.35.75.40	8715839072679	BERG Grand Champion Regular 520 Black + Safety Net Deluxe	30.35.15.40	30.99.15.40	35.72.63.02	144	95	600	120	30	390	275	180
30.35.95.40	8715839074994	BERG Grand Champion Regular 520 Black + Safety Net DLX XL	30.35.15.40	30.99.15.90	35.76.05.00	144	95	600	120	30	390	315	220



BERG GRAND CHAMPION

Choose the unbeaten Champion!



Article number	EAN - Code	Product name	Package 1	Package 2	Package 3	Number of springs	Entrance height in cm	Test-weight in kg	Max user weight in kg	Padding thickness in mm	Width padding in mm	Total height trampoline in cm	Safety Net height in cm
30.33.73.71	8715839071764	BERG Grand Champion InGround 350 Green + Safety Net Deluxe	30.33.13.70	35.72.64.01	-	80	27	550	110	30	390	207	180
30.33.74.71	8715839071771	BERG Grand Champion InGround 470 Green + Safety Net Deluxe	30.33.14.70	35.72.65.01	-	112	27	600	120	30	390	207	180
30.33.75.31	8715839071788	BERG Grand Champion InGround 520 Grey + Safety Net Deluxe	30.33.15.30	30.99.15.90	35.72.63.02	144	27	600	120	30	390	207	180
30.33.95.30	8715839072389	BERG Grand Champion InGround 520 Grey + Safety Net DLX XL	30.33.15.30	30.99.15.90	35.76.05.00	144	27	600	120	30	390	247	220
30.33.75.71	8715839071795	BERG Grand Champion InGround 520 Green + Safety Net Deluxe	30.33.15.70	30.99.15.90	35.72.63.02	144	27	600	120	30	390	207	180
30.33.95.70	8715839072396	BERG Grand Champion InGround 520 Green + Safety Net DLX XL	30.33.15.70	30.99.15.90	35.76.05.00	144	27	600	120	30	390	247	220
30.33.75.40	8715839072686	BERG Grand Champion InGround 520 Black + Safety Net Deluxe	30.33.15.40	30.99.15.40	35.72.63.02	144	27	600	120	30	390	207	180
30.33.95.40	8715839075007	BERG Grand Champion InGround 520 Black + Safety Net DLX XL	30.33.15.40	30.99.15.90	35.76.05.00	144	27	600	120	30	390	247	220



BERG GRAND CHAMPION

Choose the unbeaten Champion!

SPORTS



Article number	EAN - Code	Product name	Package 1	Package 2	Package 3	Number of springs	Entrance height in cm	Test-weight in kg	Max user weight in kg	Padding thickness in mm	Width padding in mm	Total height trampoline in cm	Safety Net height in cm
30.33.13.70	8715839067552	BERG Grand Champion InGround 350 Green	-	-	-	80	27	550	110	30	390	27	-
30.33.14.70	8715839067576	BERG Grand Champion InGround 470 Green	-	-	-	112	27	600	120	30	390	27	-
30.33.25.30	8715839067484	BERG Grand Champion InGround 520 Grey	30.33.15.30	30.99.15.90	-	144	27	600	120	30	390	27	-
30.33.25.70	8715839067477	BERG Grand Champion InGround 520 Green	30.33.15.70	30.99.15.90	-	144	27	600	120	30	390	27	-
30.33.25.40	8715839072716	BERG Grand Champion InGround 520 Black	30.33.15.40	30.99.15.40	-	144	27	600	120	30	390	27	-



BERG GRAND CHAMPION ACCESSORIES

Choose the unbeaten Champion!

Accessory	Art. nr.	Product weight	Product weight + box	Box size in cm
1 BERG Grand Weather Cover Extra 350 Green	35.97.37.00	4.9 kg	5.6 kg	58x38x12
2 BERG Grand Weather Cover Extra 470 Green	35.97.47.00	7.8 kg	8.6 kg	58x38x16
3 BERG Grand Weather Cover Extra 520 Grey	35.99.68.00	10.3 kg	10.9 kg	42x21x57
4 BERG Grand Weather Cover Extra 520 Green	35.99.58.01	10.3 kg	10.9 kg	42x21x57



High-quality weatherproof PVC sail cloth.



Easy to fit, includes hooks for extra strong attachment.

Special drainage holes in the weather cover ensure that the jumping mat does not sag during heavy rainfall.



BERG GRAND CHAMPION ACCESSORIES

Choose the unbeaten Champion!

Accessory	Art. nr.	Package 1	Package 2	Product weight	Product weight + box	Box size in cm
1 BERG Ladder L*	35.90.04.00	-	-	2.7 kg	3.4 kg	84x6x24
2 BERG Ladder Platform + Ladder L*	35.90.54.00	35.90.04.00	35.90.03.00	5.5 kg	7.3 kg	56x14x54 + 24x84x6

* For trampolines measuring 85, 90 and 95 cm high. The ladder is height adjustable.



The steps are covered with an anti-slip material that allows water to seep through it.



By attaching the unique BERG Ladder Platform to the ladder, you can climb onto or off the trampoline even more easily.





BERG GRAND CHAMPION ACCESSORIES

Choose the unbeaten Champion!

Accessory	Art. nr.	Product weight	Product weight + box	Box size in cm
1 BERG Anchor set	35.99.10.00	1.4 kg	1.5 kg	30x10x10



Secure your trampoline more firmly with this anchor set for even more safety.





BERGTOYS.COM